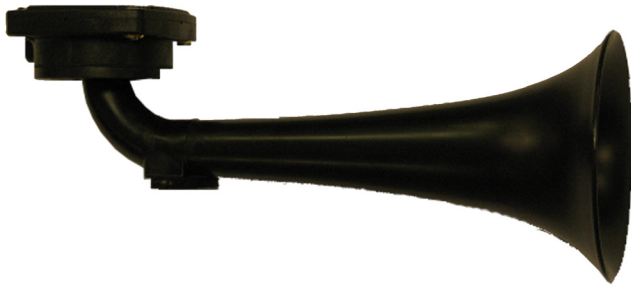

TYFON WHISTLE types KT 75/400, KTV 75/400

**TYFON KT 75/400**

(Horn only)

**TYFON KTV 75/400**

(Horn complete with valve unit and mounting bracket)

General Information

- Light, rigid and powerful signaling apparatus for different applications e.g. aboard ships, in industry, for military applications and for heavy vehicles etc.
- Material: Plastic resin of high impact and vibration strength, certain parts glass-fiber reinforced.
- Entirely maintenance-free. The diaphragm never wears out.

Technical Data

Frequency:

Basic note 400 Hz, completed by power and noise penetrating harmonics.

Sound level:

Sound Pressure Level 136 dB(A) measured at 1 m, equivalent to 120 dB(A) at 6 m and 106 dB at 30m

Supply compressed air:

Working pressure: 0,2 - 0,5 MPa* (2 - 5 bar)*
or (29 - 72.5 psi)*
Air consumption: 5 NI/sec free air (0.18 cf/sec)

Weight:

Whistle only: 0,34kg (0.7lbs)

Solenoid Valve TV 88

Standard voltage for Solenoid Valve TV 88:

DC: 24V 115V, 230V **AC:** 115V 230V

Mounting

The valve is delivered with filter and complete fittings for plastic tubing on the outlet side and for copper piping with O.D. 8mm (0.3") on the inlet side.

The valve should not be placed outdoors without protective cover.

The short connection between valve and signal apparatus should preferably be of flexible material. (Rubber hose or plastic tubing). For distinct code signals, the pipe line must not be longer than 6m between WHISTLE and Valve.

When placed outdoors the valve should be protected with cover.

Note: Blow the pipe line thoroughly clean with compressed air before connecting to signal apparatus or valve.

Units, dimensions and mounting alternatives

Dimensions (footprint)

Whistle KTV 75/400 compl. with Valve Unit:

Length overall	375 mm
Horn diamete	125 mm
Height (KT 75/400 only)	110 mm
Weight (KT 75/400 only)	0.34 kg
Inlet hole KT 75/400	BSP 1/8
TV 88	copper pipe OD 8mm

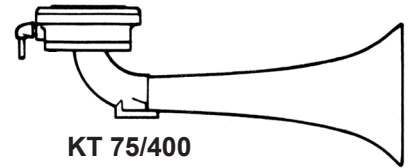

Spare parts

No.	Name.	Material.	Ref. no.
1	Cover	Plastic	32171136
2	Diaphragm KM 75 BT with O-ring	Titanium nitrile rubber	39880291
3	Bend fitting 1/8"	Brass	32320013
4	Bracket	Stainless steel	39880123

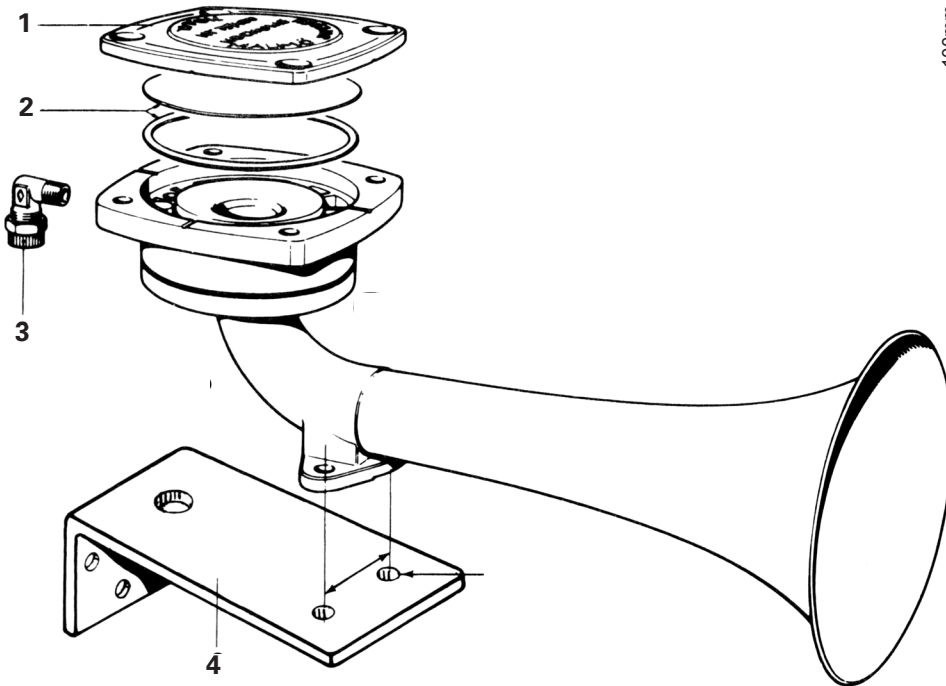
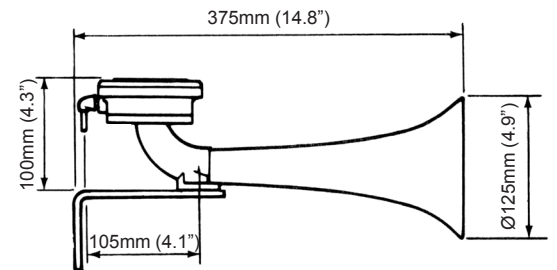
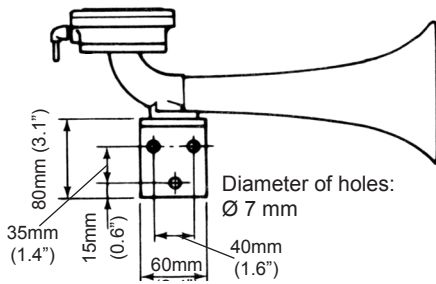
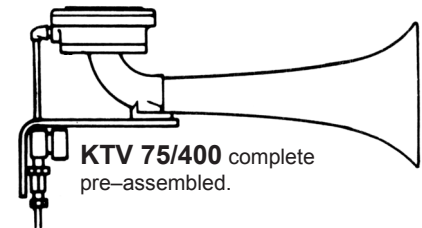
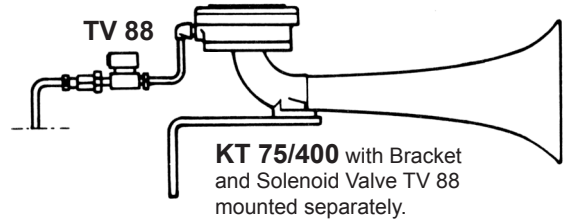

Subject to alteration without notice.