

# TRANBERG® BlueLine Navigation Light

TEF 2880 LED

For Vessels 20-50m in Length



R. STAHL TRANBERG navigation lights are all designed for rough environments. It is the policy of R. STAHL TRANBERG to provide products and services that meet the highest standards of quality in the industry and the performance needs and expectations of our customers.

Achievement of this objective requires that all products perform reliably and efficiently and in a manner that assures continuing market competitiveness. The design of TRANBERG navigation lights is based on many years of experience and extensive research in the field of professional Marine lighting.

Carefully selected materials are used to ensure maximum performance, low maintenance and a long trouble free life. Proven through years of use in rough environments, navigation lights from R. STAHL TRANBERG are the obvious choice by many vessel designers, ship owners and yards throughout the world.

## Application

- Navigation light for ships 20-50m in length.
- Signal light required by various national waters and canal authorities.

## Features and benefits

- Both simplex (single light source) and duplex (two light source) versions.
- Compact dimensions.
- Up to 200 000 working hours. (Duplex lights: 100 000 h for each light source).
- Monitored light source.
- Build-in timer.
- Easy installation - The QPD plugs from Phoenix Contact allows for a faster and more secure cable installation.
- Glass lens.
- Patent pending.

## Options

- White painted housing
- Single cable entry for duplex lights
- Contact R. STAHL TRANBERG for other combinations or features.

## Approvals and certificates

DNV-MEDB000048S

DNV-MERD000048S

ABS-23-2490533-PDA



\* Black is standard, white painted is an option.

## Technical Data

Material:	Anodized black, seawater resistant aluminium, stainless steel and glass
Working hours:	100 000 h (each light source)
Power supply:	24V DC -25% / +30%
Power consumption:	Max. 22W, dependent on model
Ingress protection:	IP 66/67
Operating temperature:	-30° to +55°C
Light Source:	LED
Weight:	Simplex 2,0 kg & Duplex 2,5 kg

TRANBERG STAHL

THE STRONGEST LINK.

R. STAHL TRANBERG AS

Main office | Strandsvingen 6 | N-4032 Stavanger, Norway | T +47 51 57 89 00 | E info.no-st@r-stahl.com | stahl-tranberg.com

# TRANBERG® BlueLine Navigation Light

TEF 2880 LED

For Vessels 20-50m in Length

## Dimensions

*Simplex*

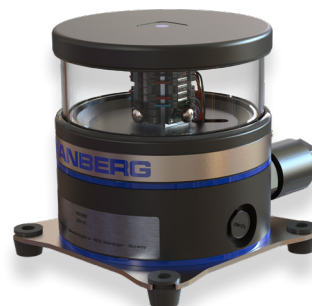
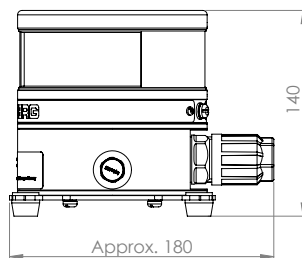
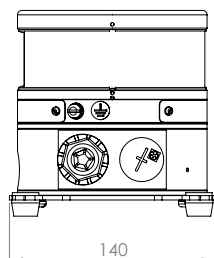
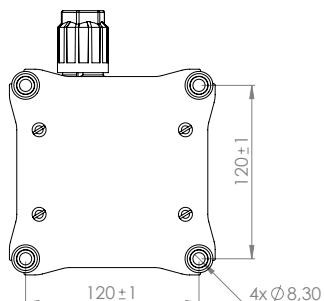

280A115721

*Duplex*

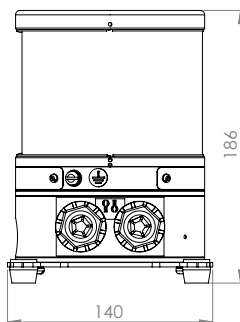
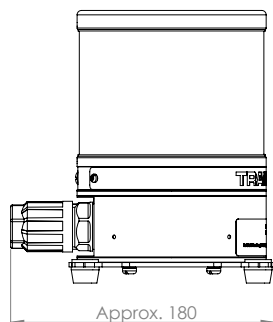
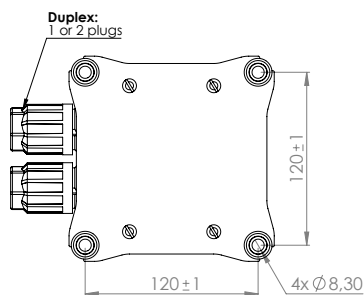

280A115720



R. STAHL TRANBERG AS

Main office | Strandsvingen 6 | N-4032 Stavanger, Norway | T +47 51 57 89 00 | E info.no-st@r-stahl.com | stahl-tranberg.com

TRANBERG

# TRANBERG® BlueLine Navigation Light

TEF 2880 LED

For Vessels 20-50m in Length

Description "COLREG"	Lantern type, horizontal sector	Color	Visible Range	Part No. Simplex	Part No. Duplex
TRANBERG® BlueLine Navigation light	Masthead, 225°	White	5 nm	2880 21500	2880 81500
TRANBERG® BlueLine Navigation light	Port, 112,5°	Red	2 nm	2880 22200	2880 82200
TRANBERG® BlueLine Navigation light	Starboard, 112,5°	Green	2 nm	2880 24200	2880 84200
TRANBERG® BlueLine Navigation light	Stern, 135°	White	2 nm	2880 31200	2880 91200
TRANBERG® BlueLine Navigation light	Towing stern, 135°	Yellow	2 nm	2880 33200	2880 93200
TRANBERG® BlueLine Navigation light	All-round white, 360°	White	2 nm	2880 01200	2880 61200
TRANBERG® BlueLine Navigation light	All-round red, 360°	Red	2 nm	2880 02200	2880 62200
TRANBERG® BlueLine Navigation light	All-round green, 360°	Green	2 nm	2880 04200	2880 64200
TRANBERG® BlueLine Navigation light	Half all-round white, 181°	White	2 nm	2880 11200	2880 71200
TRANBERG® BlueLine Navigation light	Half all-round red, 181°	Red	2 nm	2880 12200	2880 72200
TRANBERG® BlueLine Navigation light	Half all-round green, 181°	Green	2 nm	2880 14200	2880 74200
TRANBERG® BlueLine Navigation light	Signal 360°	White	1 nm	2880 01100	2880 61100
TRANBERG® BlueLine Navigation light	Signal 360°	Red	1 nm	2880 02100	2880 62100
TRANBERG® BlueLine Navigation light	Signal 360°	Green	1 nm	2880 04100	-
TRANBERG® BlueLine Navigation light	Signal 360°	Yellow	1 nm	2880 03110	-
TRANBERG® BlueLine Navigation light	Signal 360°	Blue	2 nm	2880 05200	-
TRANBERG® BlueLine Navigation light	Morse/Manouvre 360°	White	5 nm	2880 01510	2880 61510
TRANBERG® BlueLine Navigation light	Flashing Signal 120 blink/min 360°	Red	3 nm	2880 02370	-
TRANBERG® BlueLine Navigation light	Flashing Signal 180 blink/min 360°	Green	3 nm	2880 04380	-
TRANBERG® BlueLine Navigation light	Flashing Signal 120 blink/min 360°	Yellow	2 nm	2800 03270	-
TRANBERG® BlueLine Navigation light	Icebreaker Stop Light 135°	Red	3 nm	2880 32370	-
TRANBERG® BlueLine Navigation light	Suez Stern 135°	Red	3 nm	2880 32300	-

**White painted option available on inquiry**



R. STAHL TRANBERG AS

Main office | Strandsvingen 6 | N-4032 Stavanger, Norway | T +47 51 57 89 00 | E info.no-st@r-stahl.com | stahl-tranberg.com

TRANBERG

# TRANBERG® BlueLine Navigation Light

TEF 2880 LED

For Vessels 20-50m in Length

Spare parts	Description	Part No.
	Cable termination nut Ø6-11mm	50500223
	Cable termination nut Ø9-16mm	50091435
	Plug connector for cable Ø6-11 mm	50500224
	Plug connector for cable Ø9-16 mm	50500225
	Protective cap for unused cable entries IP68	50500226
	Breather plug M12 IP68	50091434
	Stopping plug M25	50091436
	Standoff feet M8, set of 4 pcs	7247
	Mounting adapter to 155x155 mm M10 hole pattern	6694
	Mounting adapter to TEF 2850 & TEF 2870 hole pattern	6693



TRANBERG

R. STAHL TRANBERG AS

Main office | Strandsvingen 6 | N-4032 Stavanger, Norway | T +47 51 57 89 00 | E info.no-st@r-stahl.com | stahl-tranberg.com