

TRANBERG® BlueLine Floodlight

TEF 2581 LED 5000 /10 000 lm

For Area Lighting



TRANBERG® BlueLine Series set the standard for high quality, cost-effective marine lighting for today's ships and delivers reduced CAPEX/OPEX through easy installation and no maintenance.

The Tranberg® BlueLine Series has been designed to provide marine operators with a high quality marine floodlight.

The series provides the latest safety, sustainability and connectivity standards required for today's modern ship designs.

Application

- Area lighting for ships, such as deck areas, rescue zones, walkways, crane booms, derricks etc.
- Lighting of docks, fishing gear and any other area or equipment located onboard or near the ship (20 meter distance).
- Mainly to be used to illuminate smaller areas and /or smaller ships.
- Suitable for harsh environments.

Features and benefits

- Lightweight.
- Plug & play -Fast and easy installation.
- Corrosion resistant.
- Uniform light distribution.
- Maintenance free - sealed for life.
- DALI available.

Approvals and certificates

CE

RoHS



Technical Data

Material:	Seawater resistant aluminium, powder coated (corrosion class C5M), glass, AISI 316L Bracket
Input voltage:	200-240V AC / 24V DC
Maximum load capacity for a 16A B circuit breaker:	13 pcs lamps can be connected on the same circuit
Maximum load capacity for a 16A C circuit breaker:	22 pcs lamps can be connected on the same circuit
Wiring in series 24 VDC:	No through wiring possible due to the high current
Light Source:	LED
Light distribution:	Narrow, Medium, Wide
Light output:	Up to 10 000 lm
CRI:	>70
Color temperature:	2200K, 4000K & 5000K
Power consumption:	5000 lm: 40W, 10 000 lm: 77W
Ingress protection:	IP66/67
Weight w/mounting bracket:	5000 lm approx. 4,8 kg 10 000 lm approx. 6,3 kg
Cable entries:	1x M25 QPD plug for cables up to 2,5mm ² 1x M25 stopping plug
Surge protection:	LED driver: Differential Mode 6kV, Common Mode 10kV
Operating temperature:	-40° to +55°C
Lifetime:	Load 80% > 120 000h

TRANBERG STAHL

THE STRONGEST LINK.

R. STAHL TRANBERG AS

Main office | Strandsvingen 6 | N-4032 Stavanger, Norway | T +47 51 57 89 00 | E info.no-st@r-stahl.com | stahl-tranberg.com

TRANBERG® BlueLine Floodlight

TEF 2581 LED 5000 /10 000 lm

For Area Lighting on Smaller Vessels

Light distribution 5000lm Narrow

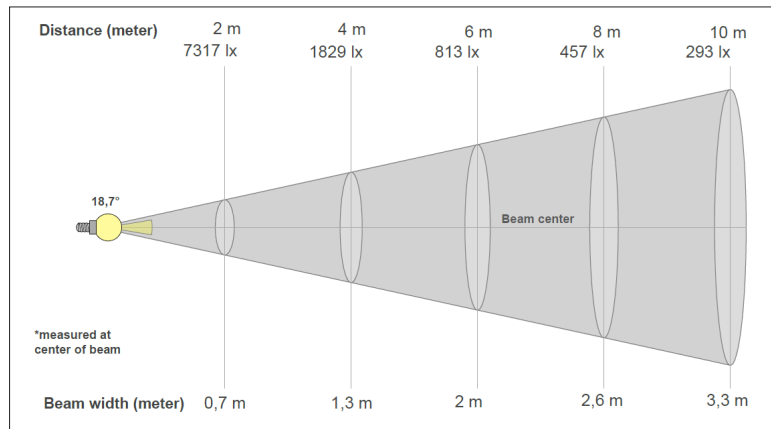
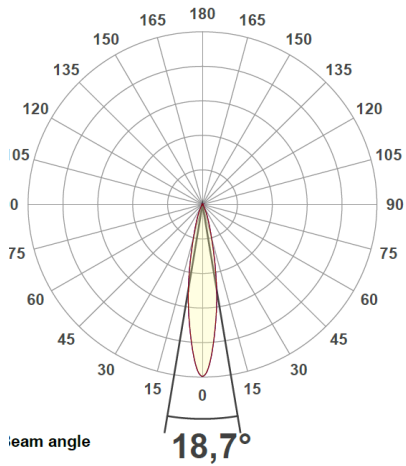

Light distribution 5000lm Medium

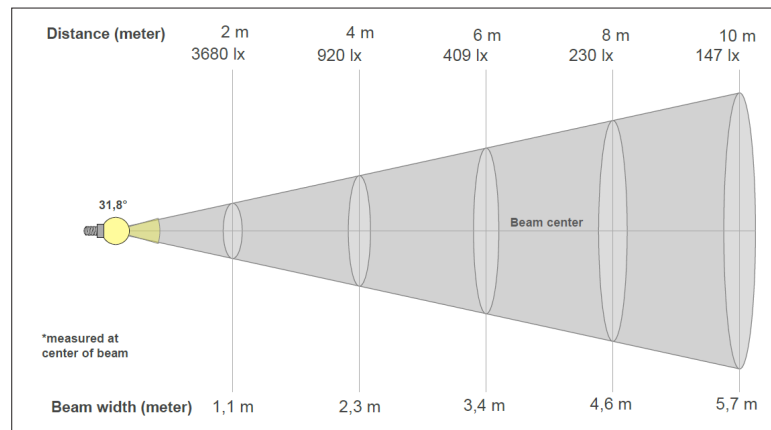
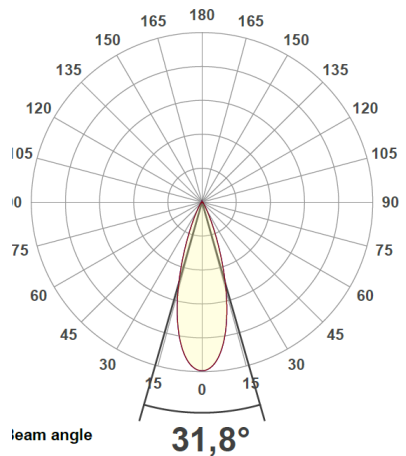

Light distribution 5000lm Wide

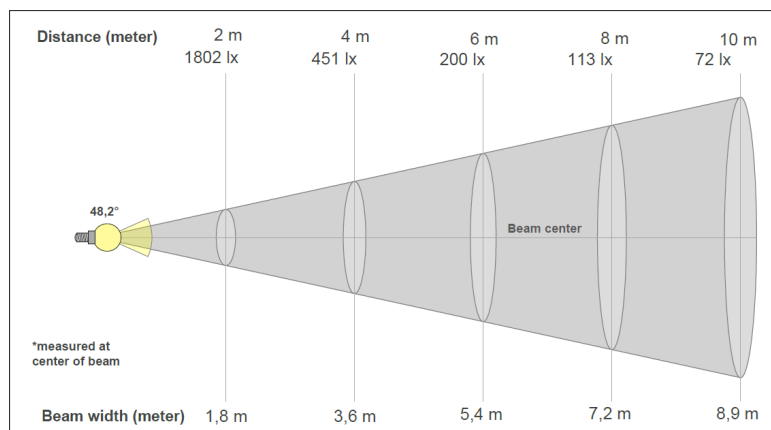
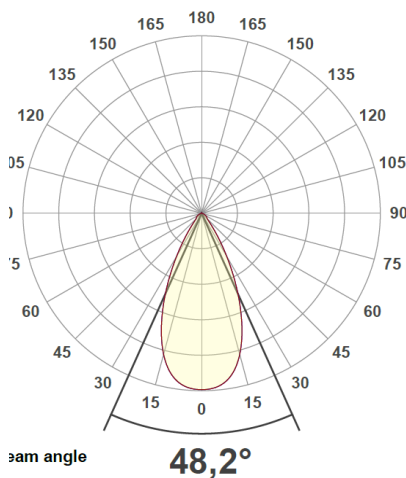

R. STAHL TRANBERG AS

Main office | Strandsvingen 6 | N-4032 Stavanger, Norway | T +47 51 57 89 00 | E info.no-st@r-stahl.com | stahl-tranberg.com

TRANBERG

TRANBERG® BlueLine Floodlight

TEF 2581 LED 5000 /10 000 lm

For Area Lighting on Smaller Vessels

Light distribution 10000lm Narrow

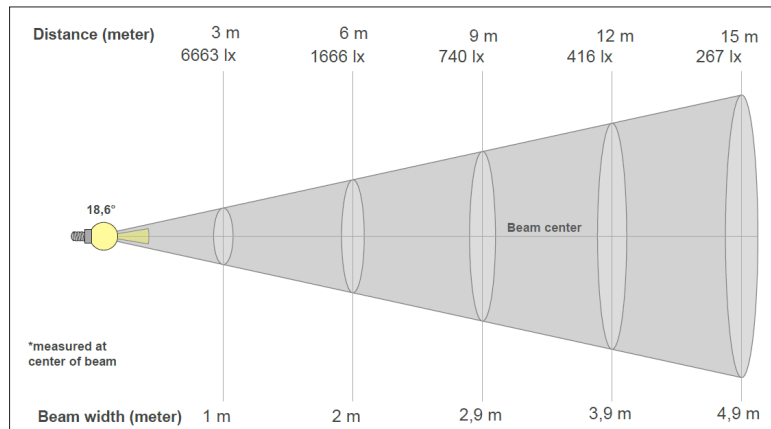
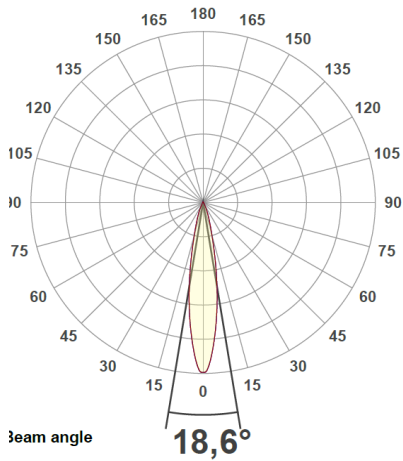

Light distribution 10000lm Medium

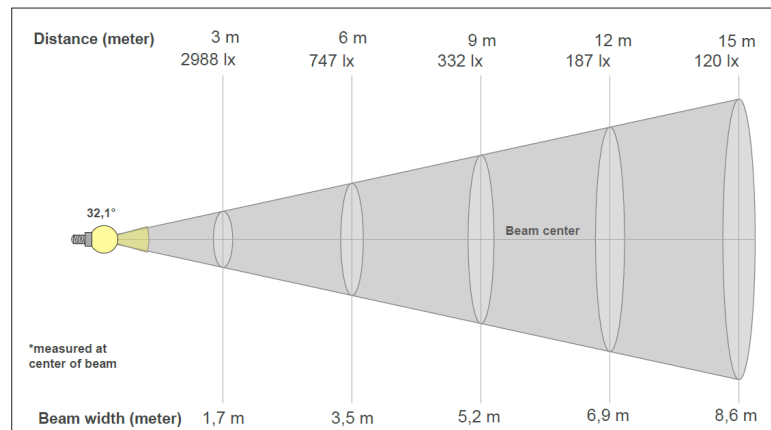
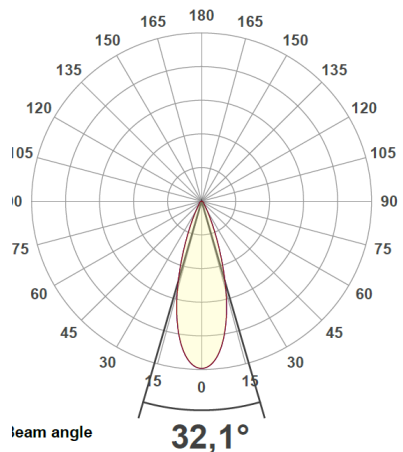

Light distribution 10000lm Wide

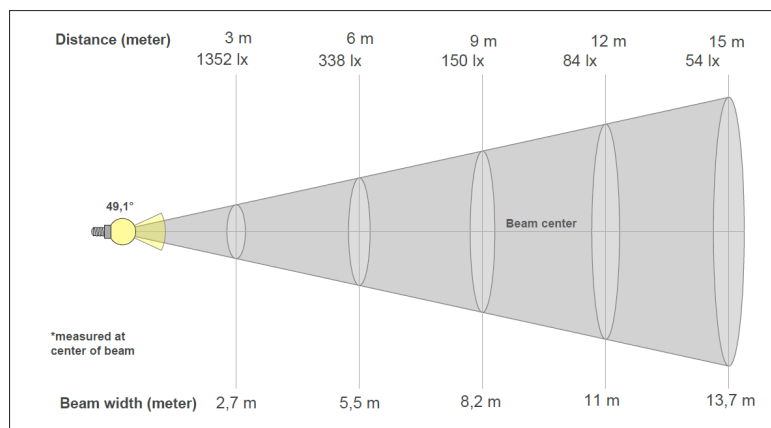
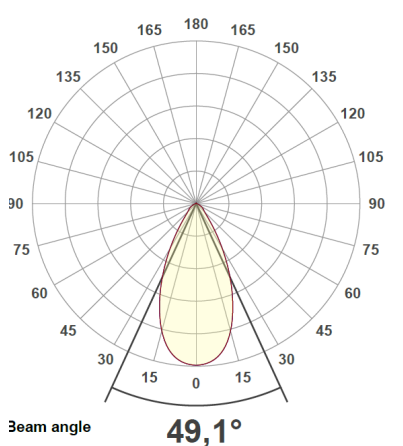

R. STAHL TRANBERG AS

Main office | Strandsvingen 6 | N-4032 Stavanger, Norway | T +47 51 57 89 00 | E info.no-st@r-stahl.com | stahl-tranberg.com

TRANBERG

TRANBERG® BlueLine Floodlight

TEF 2581 LED 5000 /10 000 lm

For Area Lighting on Smaller Vessels

Description	Part No.	Part No.
	Standard version	DALI version
TRANBERG® BlueLine LED Floodlight 5000 lm 200-240VAC, 2200K, NARROW	258111211	258151211
TRANBERG® BlueLine LED Floodlight 5000 lm 200-240VAC, 4000K, NARROW	258111411	258151411
TRANBERG® BlueLine LED Floodlight 5000 lm 200-240VAC, 5000K, NARROW	258111511	258151511
TRANBERG® BlueLine LED Floodlight 5000 lm 24VDC, 2200K, NARROW	258112211	-
TRANBERG® BlueLine LED Floodlight 5000 lm 24VDC, 4000K, NARROW	258112411	-
TRANBERG® BlueLine LED Floodlight 5000 lm 24VDC, 5000K, NARROW	258112511	-
TRANBERG® BlueLine LED Floodlight 10 000 lm 200-240VAC, 2200K, NARROW	258121211	258161211
TRANBERG® BlueLine LED Floodlight 10 000 lm 200-240VAC, 4000K, NARROW	258121411	258161411
TRANBERG® BlueLine LED Floodlight 10 000 lm 200-240VAC, 5000K, NARROW	258121511	258161511
TRANBERG® BlueLine LED Floodlight 5000 lm 200-240VAC, 2200K, MEDIUM	258111221	258151221
TRANBERG® BlueLine LED Floodlight 5000 lm 200-240VAC, 4000K, MEDIUM	258111421	258151421
TRANBERG® BlueLine LED Floodlight 5000 lm 200-240VAC, 5000K, MEDIUM	258111521	258151521
TRANBERG® BlueLine LED Floodlight 5000 lm 24VDC, 2200K, MEDIUM	258112221	-
TRANBERG® BlueLine LED Floodlight 5000 lm 24VDC, 4000K, MEDIUM	258112421	-
TRANBERG® BlueLine LED Floodlight 5000 lm 24VDC, 5000K, MEDIUM	258112521	-
TRANBERG® BlueLine LED Floodlight 10 000 lm 200-240VAC, 2200K, MEDIUM	258121221	258161221
TRANBERG® BlueLine LED Floodlight 10 000 lm 200-240VAC, 4000K, MEDIUM	258121421	258161421
TRANBERG® BlueLine LED Floodlight 10 000 lm 200-240VAC, 5000K, MEDIUM	258121521	258161521
TRANBERG® BlueLine LED Floodlight 5000 lm 200-240VAC, 2200K, WIDE	258111231	258151231
TRANBERG® BlueLine LED Floodlight 5000 lm 200-240VAC, 4000K, WIDE	258111431	258151431
TRANBERG® BlueLine LED Floodlight 5000 lm 200-240VAC, 5000K, WIDE	258111531	258151531
TRANBERG® BlueLine LED Floodlight 5000 lm 24VDC, 2200K, WIDE	258112231	-
TRANBERG® BlueLine LED Floodlight 5000 lm 24VDC, 4000K, WIDE	258112431	-
TRANBERG® BlueLine LED Floodlight 5000 lm 24VDC, 5000K, WIDE	258112531	-
TRANBERG® BlueLine LED Floodlight 10 000 lm 200-240VAC, 2200K, WIDE	258121231	258161231
TRANBERG® BlueLine LED Floodlight 10 000 lm 200-240VAC, 4000K, WIDE	258121431	258161431
TRANBERG® BlueLine LED Floodlight 10 000 lm 200-240VAC, 5000K, WIDE	258121531	258161531



R. STAHL TRANBERG AS

Main office | Strandsvingen 6 | N-4032 Stavanger, Norway | T +47 51 57 89 00 | E info.no-st@r-stahl.com | stahl-tranberg.com

TRANBERG

TRANBERG® BlueLine Floodlight

TEF 2581 LED 5000 /10 000 lm

For Area Lighting on Smaller Vessels

Dimensions

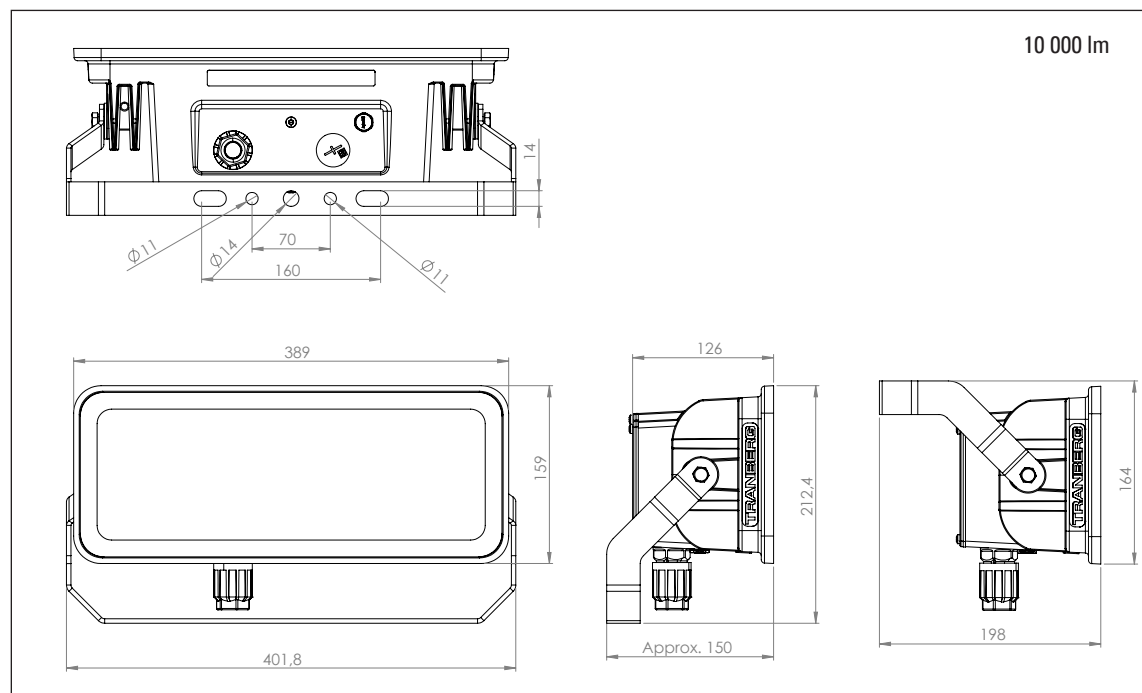
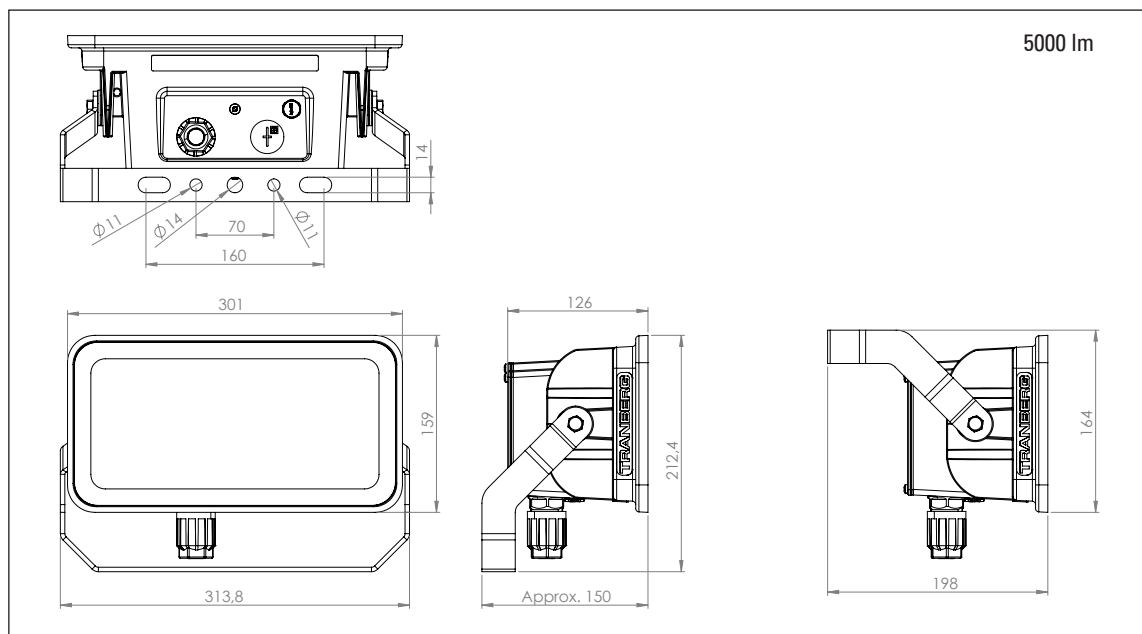

R. STAHL TRANBERG AS

Main office | Strandsvingen 6 | N-4032 Stavanger, Norway | T +47 51 57 89 00 | E info.no-st@r-stahl.com | stahl-tranberg.com

TRANBERG