

CONNECT AND PROTECT

Accessories

SUPPORTS

Support brackets are used to fix equipment such as thermostats or junction boxes on pipes or cable trays. Support brackets require additional pipe straps which have to be ordered separately.

They include a set of M6 and/or M4 fixing screws, nuts, washers and spring lock washers for the fixation of one junction box or thermostat. They are fabricated in stainless steel (SS304, and passivation)

The table below outlines the typical compatibility of each bracket with relevant equipment, for other equipment please contact nVent representative.

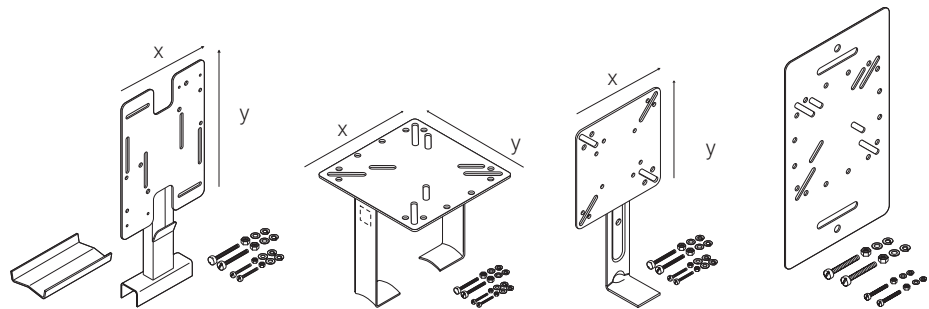

	SB-100 192932-000	SB-101 990944-000	SB-110 707366-000	SB-130** 1244-006602
AT-TS-13	X	X	X	X
AT-TS-14	X	X	X	X
JB-82	X	X	X	X
JB-EX-20(-EP)	X	X	X	X
JB-EX-21	X	X		X
JB-EX-21/35MM2				
JB-EX-25/35MM2				
JB-EX-32/35MM2				
JBU-100(-L)-E(P)	X	X		X
MONI-PT100-EXE		X		X
MONI-PT100-NH		X		X
MONI-PT100-4/20mA		X		X
RAYSTAT V5	X	X		X
RAYSTAT-EX-02	X	X	X	X
ETS-05	X	X	X	X
NGC-20-C(L)-E				
T-M-10-S/+x+y	X	X		X
T-M-20-S/+x+y(/EX)			X	

**Support bracket for fixation to cable trays

TECHNICAL DATA

	SB-100 192932-000	SB-101 990944-000	SB-110 707366-000	SB-130** 1244-006602
Plate size (mm) X x Y	160 x 230	160 x 160	130 x 130	180 x 315
Distance pipe-plate (mm)	100	160	100	N.A.
Number of pipe straps required	2	2	1	2
Max. pipe temperature (°C)	230	230	230	N.A.
Weight (kg)	0.7	0.59	0.4	0.62

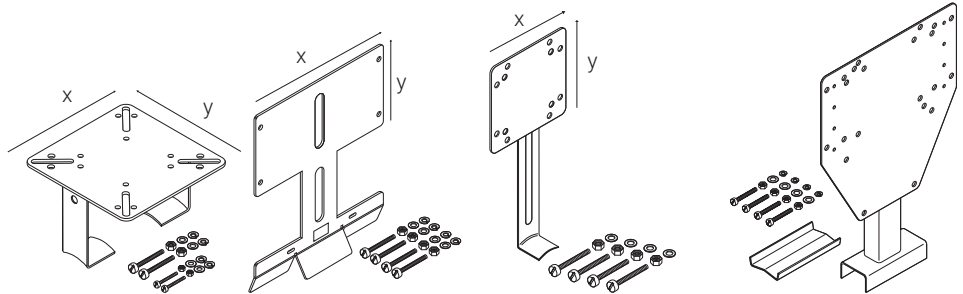

	SB-111 579796-000	SB-120 165886-000	JB-SB-26 338265-000	SB-125 1244-00603
AT-TS-13	x			
AT-TS-14	x			
JB-82	x			x
JB-EX-20(-EP)	x			
JB-EX-21				
JB-EX-21/35MM2	x*			
JB-EX-25/35MM2	x*			
JB-EX-32/35MM2	x*			
JBU-100(-L)-E(P)				x
MONI-PT100-EXE	x		x	
MONI-PT100-NH	x		x	
MONI-PT100-4/20mA	x		x	
RAYSTAT V5				x
RAYSTAT-EX-02	x			x
ETS-05	x			
NGC-20-C(L)-E		x		x
T-M-10-S/+x+y	x			
T-M-20-S/+x+y(/EX)		x		x

* Use 2 brackets per junction box

TECHNICAL DATA

	130 x 130	220 x 120	80 x 80	220 x 232
Plate size (mm) X x Y	130 x 130	220 x 120	80 x 80	220 x 232
Distance pipe-plate (mm)	100	120	100	100
Number of pipe straps required	2	2	1	2
Max. pipe temperature (°C)	230	230	230	230
Weight (kg)	0.48	0.66	0.2	0.9

LABELS AND TAGS

Warning labels indicate the presence of electrical heat-tracing under the insulation of the pipe or other equipment. (min. of 1 label per 5 m of heat-tracing line). Also suitable for stainless steel pipes.



Language	EHT label reference	Product number
Arabic	LAB-ETL-AR	036236-000
Bulgarian	LAB-ETL-BG	1244-002183
Czech	LAB-ETL-CZ	731605-000
Danish	LAB-ETL-DK	C97690-000
Dutch	LAB-ETL-NL	749153-000
English	LAB-I-01	938947-000
Estonian/English	LAB-ETL-EN/EE	1244-001415
Finnish/Swedisch	LAB-ETL-SE/FI	756479-000
French	LAB-I-05	883061-000
German/French/Italian (230V)	LAB-ETL-DE/FR/IT	148648-000
German	LAB-ETL-DE	597779-000
Hungarian	LAB-ETL-HU	623725-000
Italian	LAB-ETL-IT	C97688-000
Kazakh/Russian/English	LAB-ETL-KZ/RU/EN	1244-017393
Latvian	LAB-ETL-LV	841822-000
Lithuanian	LAB-ETL-LT	105300-000
Norwegian	LAB-ETL-NO	C97689-000
Norwegian/English	LAB-ETL-EN/NO	165899-000
Polish	LAB-ETL-PL	258203-000
Portugese	LAB-ETL-PT	945960-000
Romanian	LAB-ETL-RO	902104-000
Russian	LAB-ETL-RU	574738-000
Russian/English	LAB-ETL-EN/RU	1244-001060
Russian/English/Azeri	LAB-ETL-AZ/RU/EN	1244-012283
Russian/English/Uzbek	LAB-ETL-UZ/RU/EN	1244-022143
Spanish	LAB-ETL-ES	C97686-000
Swedish	LAB-ETL-SE	691703-000
Turkish/English	LAB-ETL-EN/TR	1244-014860



Language	Component label reference	Product number
English	LAB-I-02	774499-000
Russian/English	LAB-I-02/E/R LAB-ENDSEAL	1244-001059 146909-000
English	ETL-END-SEAL LAB-SPLICE	103405-000 007063-000

STABILIZED DESIGN LABELS

If compliance to the T-class or A.I.T. cannot be achieved by the unconditional T-rating of the heating cable, the hazardous area regulations require that cable sheath temperature is determined by the rules of stabilized design as per EN 60079-30 and the heating circuit is marked accordingly. The following labels are available for this purpose (min.1 label per heating circuit)



LAB-I-35

Stabilized design sticker. To be installed when power-limiting VPL heating cables are used in hazardous areas.

PN: 574124-000

Weight: 0,0015 kg

LAB-EX-XTV-KTV

Aluminum tag plate for XTV and KTV self-regulating heating cables. To be installed if T-class compliance was proven by stabilized design and not by unconditional T-rating.

PN: 1244-011961 Weight: 0.04 kg

LAB-EX-FxT

Aluminum tag plate. To be installed when parallel constant wattage FMT or FHT heating cables are used in hazardous areas.

PN: 1244-006953 Weight: 0.04 kg

PI-LABEL-EX

Aluminum tag plate. To be installed when series polymer insulated XPI & XPI-S heating cables are used in hazardous areas.

PN: 1244-006940 Weight: 0.04 kg

PI-LABEL-NH

Aluminum tag plate. To be installed when series polymer insulated XPI & XPI-S heating cables are used non hazardous areas.

This label is not mandatory but highly recommended for future reference.

PN: 1244-006941 Weight: 0.04 kg

PIPE STRAPS

Metal straps for pipe mounting of integrated power connections, above the insulation tees and end seals as well as support brackets and the tubular insulation entry. Banding: stainless steel

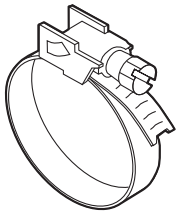

Pipe outer diameter in mm	(inches)	Pipe strap	PN (Weight)
20 - 47	(1/2" - 1 1/4")	PSE-047	700333-000 (0.017 kg)
40 - 90	(1 1/4" - 3")	PSE-090	976935-000 (0.024 kg)
60 - 288	(2" - 10")	PSE-280	664775-000 (0.052 kg)
60 - 540	(2" - 20")	PSE-540	364489-000 (0.052 kg)

PIPE STRAPS

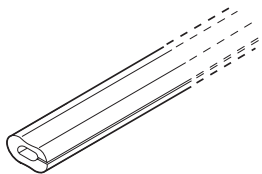

G-02

Silicone grommet that protects the heating cable at sharp edges such as endplates of insulation cladding, flanges etc. It can be cut-to-length and resists temperatures up to 215°C.

Sold in pieces of 1 m.

PN: 412549-000 Weight: 0.37 kg/m)

FIXING MATERIALS

Self-adhesive tape for fixing the heating cables on pipes or other equipment.



GT-66

Glass cloth tape for attaching heating cable to pipe.

Not for stainless steel pipes or for installation temperatures below 5°C.

20 m per roll, 12 mm width.

PN: C77220-000 Weight: 0.053 kg

GS-54

Glass cloth tape for attaching heating cable to pipe.

For stainless steel pipes or for any installation below 5°C.

16.5 m per roll, 12 mm width.

PN: C77221-000 Weight: 0.048 kg

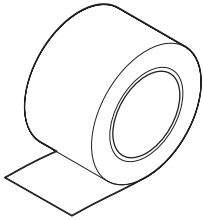

ATE-180

Aluminium tape* for attaching heating cables and thermostat sensors to pipes and tanks. Minimum installation temperature: 0°C. Also suitable for stainless steel pipes.

55 m per roll, 63.5 mm width.

PN: 846243-000 Weight: 0.84 kg

*Power output of selfregulating heating cables might increase when installed with aluminium tape or other heat transfer aids. Please use TraceCalc or contact nVent representative for further details.

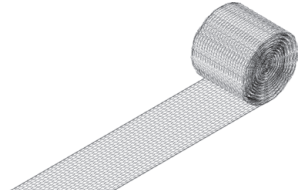

HWA-METAL-MESH-SS-50MM-10M

Stainless steel mesh for fixation of heating cables on valves, pumps or other odd-shaped surfaces. This mesh provides optimum contact and heat transfer between heating cables and heated equipment and can be used for exposure temperatures up to 400°C.

10 m per roll, 50 mm width.

PN: 1244-005772 Weight: 0.36 kg

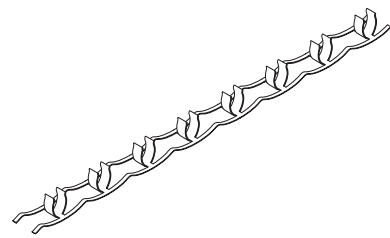

HWA-PI-FIX-SS-xMM-10M

Stainless steel clip band to attach Polymer Insulated series heating cables to pipes. Clips at regular distances to allow for even heater spacing. Band available in two sizes for different diameter ranges.

10 m per roll.

For diameters up to 5 mm, HWA-PI-FIX-SS-5MM-10M

PN: 1244-007768 Weight: 0.32 kg

For diameters up to 8 mm, HWA-PI-FIX-SS-8MM-10M

PN: 1244-007769 Weight: 0.52 kg

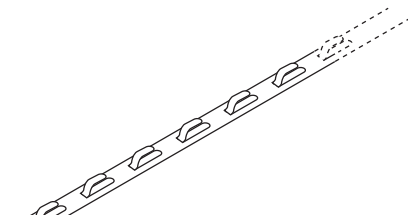

HARD-SPACER-SS-25MM-25M

Stainless steel spacer for fixing the heating cable on walls, tanks and vessels, etc.

Width spacer: 12.5 mm.

Fixing distance for cables: each 25 mm.

25 m per roll.

PN: 107826-000 Weight: 1.10 kg

TERMINALS

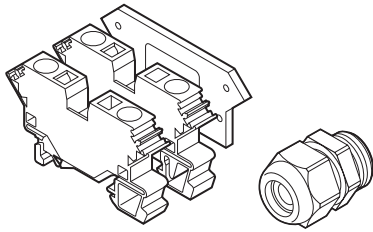

HWA-WAGO-TSTAT-KIT

Thermostat kit with supplementary terminals to connect thermostats of type RAYSTAT-EX-02 to the junction boxes JBS, JBM and JBU.

The kit includes 2 terminals Spring-type terminals (1 x L, 1 x PE), 1 power cable gland GL-36-M25, 1 end plate and 1 installation instruction.

PN: 966659-000 Weight: 0.073 kg

PTB 98 ATEX 3133 U (Terminal)

PTB 99 ATEX 3128 X (Gland)

HWA-WAGO-PHASE

Phase/neutral terminal (Ex e), spare part for various junction boxes, max. 10 mm² solid/stranded.

PN: 633476-000 Weight: 0.019 kg

PTB 98 ATEX 3133 U

HWA-WAGO-EARTH

Earth terminal (Ex e), spare part for various junction boxes, max. 10 mm² solid/stranded.

PN: 911505-000 Weight: 0.027 kg

PTB 98 ATEX 3133 U

HWA-WAGO-ENDPLATE

End plate for HWA-WAGO-..., 10 mm² terminals, spare part.

PN: 983674-000 Weight: 0.003 kg

PTB 98 ATEX 3133 U

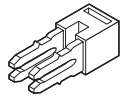

HWA-WAGO-JUMPER

Jumper to bridge HWA-WAGO-..., 10 mm² terminals, spare part.

PN: 550942-000 Weight: 0.0004 kg

PTB 98 ATEX 3133 U

HWA-WDM-PHASE-35

Phase/neutral screw terminal (Ex e), spare part for JB-EX-xx/35MM2 junction boxes, max. 35 mm² solid/stranded.

PN: 1244-006990 Weight: 0.052 kg

KEMA 98 ATEX 1683 U

HWA-WDM-EARTH-35

Earth screw terminal (Ex e), spare part for JB-EX-xx/35MM2 junction boxes, max. 35 mm² solid/stranded.

PN: 1244-006992 Weight: 0.077 kg

KEMA 98 ATEX 1683 U

HWA-WDM-EARTH-10

Earth screw terminal (Ex e), spare part for JB-EX-xx/35MM2 junction boxes, max. 10 mm² solid/stranded.

PN: 1244-006992 Weight: 0.030 kg

KEMA 98 ATEX 1683 U

HWA-WDM-JUMPER-35-2

Jumper to bridge two HWA-WDM-... 35 mm² terminals, spare part

PN: 1244-006995 Weight: 0.013 kg

KEMA 98 ATEX 1683 U

HWA-WDM-JUMPER-35-3

Jumper to bridge three HWA-WDM-... 35 mm² terminals, spare part

PN: 1244-006996 Weight: 0.020 kg

KEMA 98 ATEX 1683 U

HWA-WDM-PLATE

End plate for HWA-WDM-... 35 mm² terminals, spare part

PN: 1244-007004 Weight: 0.005 kg

GLANDS

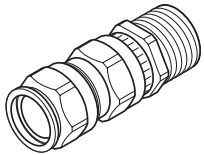

GL-33

3/4" NPT power cable gland for RAYSTAT-EX-02 (Ex d IIC)

Nickel plated brass, silicone grommet.

For use with armoured power cables with outer sheath diameter of 13.5 - 21 mm and inner sheath diameter of 10 - 15.5 mm.

PN: 1244-017517 Weight: 0.14 kg

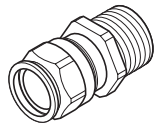

GL-34

3/4" NPT power cable gland for RAYSTAT-EX-02 (Ex d IIC)

Nickel plated brass, silicone grommet.

For use with non-armoured power cables with outer sheath diameter of 10 - 15.5 mm.

PN: 1244-017518 Weight: 0.08 kg

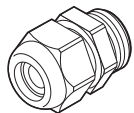

GL-36-M25

M25 power cable gland (Ex e) Polyamide.

For use with non-armoured power cables with outer diameter range 8-17,5 mm.

Temperature range: -20°C/+70°C.

Spare part for JBS-100, JBM-100 and JBU-100.

PN: 1244-019082 Weight: 0.016 kg

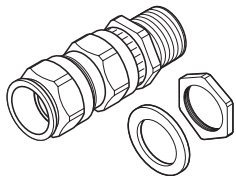

GL-38-M25-METAL

M25 power cable gland (Ex e II and Ex d IIC) for use with junction boxes with internal earth plate (-EP) or metal boxes.

Nickel plated brass, silicone grommet.

For use with armoured power cables with sheath diameter of 13.5 - 21 mm and inner sheath diameter 10 - 15.5 mm.

PN: 056622-000 Weight: 0.15 kg

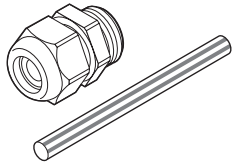
**C20-PI-PA-KIT**

cable gland (Ex e), polyamide for use with PI cables with a diameter range of 4-13mm, up to -40°C. With green/yellow sleeve.

PN: 1244-019669 Weight: 0.02 kg

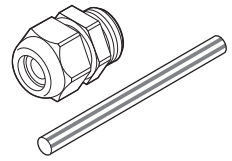
**C20-PI-M0-KIT**

cable gland (Ex e), Ni plated brass for use with PI cables with a diameter range of 5-14mm in conjunction with junction boxes with earth plate or with polymer junction boxes and an earth lug, up to -55°C. With green/yellow sleeve.

PN: 1244-019670 Weight: 0.71kg

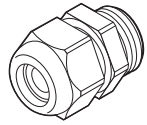
**GL-45-M32**

M32 cable gland (Ex e), polyamide for use with power cables with a diameter range of 12 - 21 mm.

PN: 1244-000 847 Weight: 0.028 kg

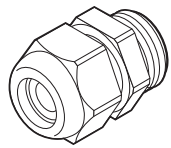
**GL-51-M40**

M40 cable gland (Ex e), polyamide for use with power cables with a diameter range of 17 - 28 mm.

PN: 1244-007003 Weight: 0.045 kg

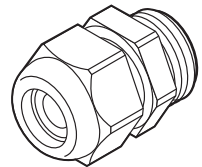
**GL-55-M25**

M25 power cable gland (Ex e) Polyamide.

For use with non-armoured power cables with outer diameter range 8 - 15 mm.

Temperature range: -55°C/+70°C

Spare part for JBS-100, JBM-100, JBU-100, JB-EX-20(-EP), JB-MB-25/16MM2 and JB-MB-26/16MM2

PN 1244-019083 Weight: 0.016 kg

PLUGS**HWA-PLUG-M20-EXE-PLASTIC**

M20 stopping plug Ex e, up to -55°C.

Polyamide.

Spare parts for various junction boxes.

PN: 1244-000 845 Weight: 0.003 kg

PTB 98 ATEX 3130

IECEX PTB 03.0000

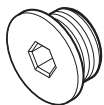
**HWA-PLUG-M25-EXE-PLASTIC**

M25 stopping plug Ex e, up to -55°C.

Polyamide.

Spare parts for various junction boxes.

PN: 434994-000 Weight: 0.007 kg

PTB 98 ATEX 3130

IECEX PTB 03.0000

ADAPTORS/REDUCERS

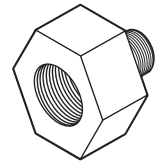
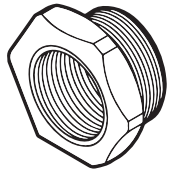

Prod Description	Male	Female	Hazardous area approved	Material	Extra accessories	Product Number (Weight)
REDUCER-M25/M20-EEXE	M25	M20	Ex e	Polyamide	None	1244-002089 (0.021 kg)
REDUCER-M32/M25-EEXE	M32	M25	Ex e	Polyamide	None	1244-000859 (0.009 kg)
REDUCER-M40/M32	M40	M32	Ex e	Polyamide	O-ring	1244-007007 (0.016 kg)
ADPT-PG16-M25-EEXE	M25	PG16	Ex e	Polyamide	O-ring	541892-000 (0.020 kg)
REDUCER-M25/20-EEXD	M25	M20	Ex d	Brass	O-ring	404287-000 (0.07 kg)
REDUCER-M25/20	M25	M20	Ex d	Brass	Locknut, Fibre washer, O-ring	630617-000 (0.07 kg)
REDUCER-M25/M20-EEXD-SS	M25	M20	Ex d	Stainless steel	O-ring	1244-002090 (0.028 kg)
REDUCER-1NPT/PG16-EEXD	1" NPT	PG16	Ex d	Stainless steel	None	414478-000 (0.10 kg)
REDUCER-1NPT/M25	1" NPT	M25	Ex d	Stainless steel	None	1244-000953 (0.55 kg)
REDUCER-M25/PG16-EEXE	PG16	M25	Ex e	Polyamide	O-ring	953780-000 (0.03 kg)
ADAPTOR-M20/25	M20	M25	Ex d	Brass	Locknut and O-ring	492799-000 (0.092 kg)
ADPT-M20/25-EEXD	M20	M25	Ex d	Brass	O-ring	684953-000 (0.09 kg)

APPROVALS

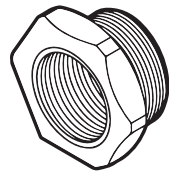

REDUCER-M25/20-EEXD

SIRA 00ATEX1094 
IECEx SIR 05.0042U

REDUCER-M25/PG16-EEXE

SIRA00ATEX3091
IECEx SIR 05.0042U

SMALL PIPE ADAPTORS

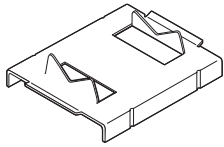

JBS-SPA

Small pipe adaptor required for pipes $\leq 1"$ (DN25), applicable for JBS-100, E-100, E-100-L E90515-000 (bag of 5 adaptors) Weight: 0.14 kg

JBM-SPA

Small pipe adaptor required for pipes $\leq 1"$ (DN25), applicable for JBM-100, T-100 D55673-000 (bag of 5 adaptors) Weight: 0.40 kg

STANDOFFS

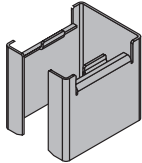

JBS-100 STANDOFF

Junction box stand off
P000003408
For insulation $120 \geq 180$ mm

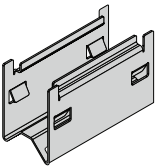

JBM-100 STANDOFF

Junction box stand off
P000003624
For insulation $120 \geq 180$ mm

POWER SUPPLY

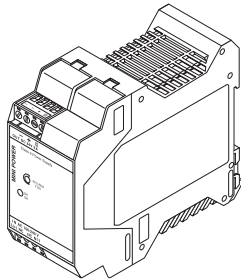

MONI-RMC-PS24

24 Vdc stabilized power supply
Wide range input (100 - 240 Vac) power supply to provide
24 Vdc input for MONI- RMC-BASE.
Surface or DIN 35 rail mounted.
PN: 972049-000 Weight: 0.28 kg

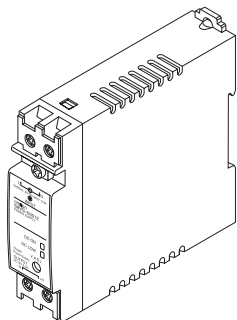

MONI-PS12

12 Vdc stabilized power supply
Wide range input (100 - 240 Vac) power supply to provide 12 Vdc input for the
nVent RAYCHEM NGC-30-CRM-E and nVent RAYCHEM NGC-30-CRMS-E cards.
DIN 35 rail mountable.
PN: 1244-001505 Weight: 0.18 kg

North America

Tel +1.800.545.6258
Fax +1.800.527.5703
thermal.info@nVent.com

Europe, Middle East, Africa

Tel +32.16.213.502
Fax +32.16.213.604
thermal.info@nVent.com

Asia Pacific

Tel +86.21.2412.1688
Fax +86.21.5426.3167
cn.thermal.info@nVent.com

Latin America

Tel +1.713.868.4800
Fax +1.713.868.2333
thermal.info@nVent.com



Our powerful portfolio of brands:

CADDY ERICO HOFFMAN RAYCHEM SCHROFF TRACER