

**Safety Regulation Group**



**CAP 437**

**Standards for Offshore Helicopter Landing  
Areas**

---

**[www.caa.co.uk](http://www.caa.co.uk)**



**Safety Regulation Group**



**CAP 437**

**Standards for Offshore Helicopter Landing  
Areas**

---

**February 2013**

© Civil Aviation Authority 2013

All rights reserved. Copies of this publication may be reproduced for personal use, or for use within a company or organisation, but may not otherwise be reproduced for publication.

To use or reference CAA publications for any other purpose, for example within training material for students, please contact the CAA at the address below for formal agreement.

ISBN 978 0 11792 792 6

First edition September 1981

Second edition December 1993

Third edition October 1998

Reprinted January 2002 incorporating amendments to date

Fourth edition September 2002 incorporating new house-style

Fifth edition August 2005

Sixth edition December 2008

Sixth edition incorporating Amendment 01/2010

Sixth edition incorporating Amendment 02/2010

Seventh edition May 2012

Seventh edition incorporating Amendment 01/2013

Enquiries regarding the content of this publication should be addressed to:

Flight Operations Inspectorate (Helicopters), Safety Regulation Group, Civil Aviation Authority, Aviation House, Gatwick Airport South, West Sussex, RH6 0YR.

The latest version of this document is available in electronic format at [www.caa.co.uk](http://www.caa.co.uk), where you may also register for e-mail notification of amendments.

Published by TSO (The Stationery Office) on behalf of the UK Civil Aviation Authority.

Printed copy available from:

TSO, PO Box 29, Norwich NR3 1GN

Telephone orders/General enquiries: 0844 477 7300

Fax orders: 0870 600 5533

[www.tsoshop.co.uk](http://www.tsoshop.co.uk)

E-mail: [caa@tso.co.uk](mailto:caa@tso.co.uk)

Textphone: 0870 240 3701

---





## List of Effective Pages

Chapter	Page	Date	Chapter	Page	Date
	iii	February 2013	Chapter 4	7	May 2012
	iv	February 2013	Chapter 4	8	February 2013
Contents	1	February 2013	Chapter 4	9	February 2013
Contents	2	February 2013	Chapter 4	10	February 2013
Contents	3	February 2013	Chapter 4	11	February 2013
Contents	4	February 2013	Chapter 4	12	February 2013
Revision History	1	May 2012	Chapter 5	1	May 2012
Revision History	2	February 2013	Chapter 5	2	May 2012
Foreword	1	May 2012	Chapter 5	3	May 2012
Foreword	2	May 2012	Chapter 5	4	May 2012
Foreword	3	May 2012	Chapter 5	5	May 2012
Foreword	4	May 2012	Chapter 5	6	May 2012
Glossary	1	May 2012	Chapter 5	7	May 2012
Glossary	2	May 2012	Chapter 6	1	May 2012
Glossary	3	May 2012	Chapter 6	2	May 2012
Glossary	4	May 2012	Chapter 6	3	February 2013
Chapter 1	1	May 2012	Chapter 6	4	February 2013
Chapter 1	2	May 2012	Chapter 6	5	May 2012
Chapter 1	3	May 2012	Chapter 6	6	May 2012
Chapter 1	4	May 2012	Chapter 6	7	May 2012
Chapter 1	5	May 2012	Chapter 7	1	May 2012
Chapter 2	1	May 2012	Chapter 7	2	May 2012
Chapter 3	1	May 2012	Chapter 7	3	May 2012
Chapter 3	2	May 2012	Chapter 7	4	May 2012
Chapter 3	3	May 2012	Chapter 7	5	May 2012
Chapter 3	4	May 2012	Chapter 7	6	May 2012
Chapter 3	5	May 2012	Chapter 7	7	May 2012
Chapter 3	6	May 2012	Chapter 8	1	May 2012
Chapter 3	7	May 2012	Chapter 8	2	May 2012
Chapter 3	8	February 2013	Chapter 8	3	May 2012
Chapter 3	9	May 2012	Chapter 8	4	May 2012
Chapter 3	10	May 2012	Chapter 8	5	May 2012
Chapter 3	11	May 2012	Chapter 8	6	May 2012
Chapter 3	12	May 2012	Chapter 8	7	May 2012
Chapter 3	13	May 2012	Chapter 8	8	May 2012
Chapter 3	14	May 2012	Chapter 8	9	May 2012
Chapter 3	15	May 2012	Chapter 8	10	May 2012
Chapter 3	16	May 2012	Chapter 8	11	May 2012
Chapter 3	17	May 2012	Chapter 8	12	May 2012
Chapter 3	18	May 2012	Chapter 8	13	May 2012
Chapter 4	1	May 2012	Chapter 8	14	May 2012
Chapter 4	2	May 2012	Chapter 8	15	May 2012
Chapter 4	3	May 2012	Chapter 8	16	May 2012
Chapter 4	4	May 2012	Chapter 9	1	May 2012
Chapter 4	5	May 2012	Chapter 9	2	February 2013
Chapter 4	6	May 2012	Chapter 9	3	May 2012

Chapter	Page	Date	Chapter	Page	Date
Chapter 9	4	May 2012	Appendix E	8	May 2012
Chapter 9	5	May 2012	Appendix E	9	May 2012
Chapter 9	6	May 2012	Appendix E	10	May 2012
Chapter 9	7	May 2012	Appendix E	11	May 2012
Chapter 9	8	May 2012	Appendix F	1	May 2012
Chapter 10	1	May 2012	Appendix G	1	February 2013
Chapter 10	2	May 2012	Appendix G	2	February 2013
Chapter 10	3	February 2013	Appendix G	3	May 2012
Chapter 10	4	February 2013			
Chapter 10	5	February 2013			
Chapter 10	6	February 2013			
Chapter 10	7	February 2013			
Chapter 10	8	February 2013			
Appendix A	1	May 2012			
Appendix A	2	May 2012			
Appendix B	1	May 2012			
Appendix B	2	May 2012			
Appendix B	3	May 2012			
Appendix C	1	May 2012			
Appendix C	2	February 2013			
Appendix C	3	February 2013			
Appendix C	4	February 2013			
Appendix C	5	May 2012			
Appendix C	6	February 2013			
Appendix C	7	February 2013			
Appendix C	8	February 2013			
Appendix D	1	May 2012			
Appendix D	2	May 2012			
Appendix D	3	May 2012			
Appendix D	4	May 2012			
Appendix D	5	May 2012			
Appendix D	6	May 2012			
Appendix D	7	May 2012			
Appendix D	8	May 2012			
Appendix D	9	May 2012			
Appendix D	10	May 2012			
Appendix D	11	May 2012			
Appendix D	12	May 2012			
Appendix D	13	May 2012			
Appendix D	14	May 2012			
Appendix D	15	May 2012			
Appendix E	1	May 2012			
Appendix E	2	May 2012			
Appendix E	3	February 2013			
Appendix E	4	February 2013			
Appendix E	5	February 2013			
Appendix E	6	February 2013			
Appendix E	7	May 2012			



# Contents

	<b>List of Effective Pages</b>	iii
	<b>Revision History</b>	1
	<b>Foreword</b>	1
	<b>Glossary of Terms and Abbreviations</b>	1
<b>Chapter 1</b>	<b>Introduction</b>	
	History of Development of Criteria for Offshore Helicopter Landing Areas, 1964-1973	1
	Department of Energy and the Health and Safety Executive Guidance on the Design and Construction of Offshore Installations, 1973 Onwards	1
	Applicability of Standards in Other Cases	4
	Worldwide Application	4
<b>Chapter 2</b>	<b>Helicopter Performance Considerations</b>	
	General Considerations	1
	Safety Philosophy	1
	Factors Affecting Performance Capability	1
<b>Chapter 3</b>	<b>Helicopter Landing Areas – Physical Characteristics</b>	
	General	1
	Helideck Design Considerations – Environmental Effects	2
	Structural Design	5
	Loads – Helicopters Landing	6
	Loads – Helicopters at Rest	7
	Size and Obstacle Protected Surfaces	7
	Surface	12
	Helicopter Tie-Down Points	14
	Perimeter Safety Net	16
	Access Points	16
	Winching (Hoist) Operations	17
	Normally Unattended Installations (NUIs)	17

<b>Chapter 4</b>	<b>Visual Aids</b>	
	General	1
	Helideck Landing Area Markings	2
	Lighting	8
	Obstacles – Marking and Lighting	11
<b>Chapter 5</b>	<b>Helideck Rescue and Fire Fighting Facilities</b>	
	Introduction	1
	Key Design Characteristics – Principal Agent	1
	Use and Maintenance of Foam Equipment	4
	Complementary Media	4
	Normally Unattended Installations	5
	The Management of Extinguishing Media Stocks	5
	Rescue Equipment	6
	Personnel Levels	6
	Personal Protective Equipment (PPE)	7
	Training	7
	Emergency Procedures	7
	Further Advice	7
<b>Chapter 6</b>	<b>Helicopter Landing Areas – Miscellaneous Operational Standards</b>	
	Landing Area Height above Water Level	1
	Wind Direction (Vessels)	1
	Helideck Movement	1
	Meteorological Information	3
	Location in Respect to Other Landing Areas in the Vicinity	5
	Control of Crane Movement in the Vicinity of Landing Areas	5
	General Precautions	5
	Installation/Vessel Helideck Operations Manual and General Requirements	6
	Helicopter Operations Support Equipment	6

<b>Chapter 7</b>	<b>Helicopter Fuelling Facilities – Systems Design and Construction</b>	
	General	1
	Product Identification	1
	Fuelling System Description	1
<b>Chapter 8</b>	<b>Helicopter Fuelling Facilities – Maintenance and Fuelling Procedures</b>	
	General	1
	Fuel Quality Sampling and Sample Retention	1
	Recommended Maintenance Schedules	4
	Filling of Transit Tanks	11
	Receipt of Transit Tanks Offshore	12
	Decanting from Transit Tanks to Static Storage	13
	Fuelling Direct from Transit Tanks	14
	Long Term Storage of Aviation Fuel	14
	Aircraft Refuelling	14
	Quality Control Documentation	16
<b>Chapter 9</b>	<b>Helicopter Landing Areas on Vessels</b>	
	Vessels Supporting Offshore Mineral Workings and Specific Standards for Landing Areas on Merchant Vessels	1
	Amidships Helicopter Landing Areas – Purpose-Built or Non-Purpose-Built Ship’s Centreline	1
	Helicopter Landing Area Marking and Lighting	3
	Ship’s Side Non-Purpose-Built Landing Area	5
	Ship’s Side Non-Purpose-Built Landing Area Markings	6
	Night Operations	8
	Poop Deck Operations	8
<b>Chapter 10</b>	<b>Helicopter Winching Areas on Vessels and on Wind Turbine Platforms</b>	
	Winching Areas on Vessels	1
	Helicopter Winching Areas on Wind Turbine Platforms	3

<b>Appendix A</b>	<b>Checklist</b>	
<b>Appendix B</b>	<b>Bibliography</b>	
	References	1
	Sources	3
<b>Appendix C</b>	<b>Specification for Helideck Lighting Scheme Comprising: Perimeter Lights, Lit Touchdown/ Positioning Marking and Lit Heliport Identification Marking</b>	
	Overall Operational Requirement	1
	Definitions	2
	The Perimeter Light Requirement	3
	The Touchdown/Positioning Marking Circle Requirement	3
	The Heliport Identification Marking Requirement	6
	Other Considerations	8
<b>Appendix D</b>	<b>Helideck Fire-Fighting Provisions for Existing Normally Unattended Installation (NUI) Assets on the United Kingdom Continental Shelf</b>	
<b>Appendix E</b>	<b>Additional Guidance Relating to the Provision of Meteorological Information from Offshore Installations</b>	
	Introduction	1
	Contents and Standardisation of the Weather Reports Issued by Each Offshore Installation	1
	Example Offshore Report	4
	Definition of an Offshore Meteorological Observer	5
	Applicability of Meteorological Equipment to Helideck Categories	6
	Design, Siting and Back-up Requirements for Meteorological Equipment Installed in Offshore Installations	6
	Calibration, Maintenance and Servicing Periods	11
<b>Appendix F</b>	<b>Procedure for Authorising Offshore Helicopter Landing Areas</b>	
<b>Appendix G</b>	<b>Guidance for Helideck Floodlighting Systems</b>	
	Introduction	1
	General Considerations for Helideck Floodlighting	1
	Improved Floodlighting System (a modified extract from the CAA's letter to industry dated 9 March 2006)	2

# Revision History

**Edition 1****September 1981**

The first edition of CAP 437 was published to give guidance on the criteria applied by the CAA in assessing the standard of helicopter offshore landing areas for worldwide use by helicopters registered in the UK. The criteria in the CAP relating to fixed and mobile installations in the area of the UK Continental Shelf were based on the helicopter landing area standards of the Department of Energy. Additional criteria were given relating to vessels used in the support of offshore mineral exploitation and tankers, cargo vessels and passenger vessels which were not subject to the Department of Energy certification. These criteria were evolved following consultation with the Department of Trade (Marine Division) and the Inter-governmental Maritime Consultative Organisation. In addition to explaining the reasons behind the chosen criteria, the first edition of CAP 437 described their application to particular classes of landing area.

**Edition 2****December 1993**

The guidance in CAP 437 was revised in the light of International Civil Aviation Organization (ICAO) recommendations and Health and Safety Executive (HSE)/CAA experience gained from offshore helideck inspections.

**Edition 3****October 1998**

Amendments were made to incorporate the results of valuable experience gained by CAA staff during three and a half years of offshore helideck inspecting with the HSE and from cooperation with the British Helicopter Advisory Board (BHAB). Analysis of the results of the inspection regime, completed in April 1995, resulted in changes to the way in which helidecks were authorised for use by helicopter operators. Other changes reflected knowledge gained from accidents, incidents, occurrences and research projects. The section concerning the airflow environment, and the impact on this environment from exhaust and venting systems, was revised. Also the paragraph numbering was changed for easier reference.

**Edition 4****September 2002**

The CAP was amended to incorporate new house-style.

**Edition 5****August 2005**

The CAP was extensively revised to incorporate valuable experience gained from CAA funded research projects conducted with the support of the UK offshore industry into improved helideck lighting, helideck environmental effects and operations to moving helidecks. The sections concerning helideck lighting were considerably revised to ensure that UK good practice adequately reflected the changes made in 2004 to the ICAO Standards and Recommended Practices (SARPs) for TLOF lighting. The fifth edition also pulled together revised requirements harmonised amongst North Sea States as a result of initiatives taken by the Group of Aerodrome Safety Regulators (GASR) Helideck Working Group.

**Edition 6****December 2008**

The sixth edition is revised to incorporate further results of valuable experience gained from CAA funded research projects conducted with the support of the UK offshore industry into improved helideck lighting and the conclusion of projects, jointly funded with the Health and Safety Executive (HSE), relating to offshore helideck environmental issues. In respect of helideck lighting, a detailed specification for stage 2 lighting systems (addressing illumination of the heliport identification 'H' marking and the Touchdown/Positioning Marking Circle) is provided in an Appendix; and a new reference to the final specification for helideck status lights systems is provided in Chapter 4. In regard to now-completed helideck environmental

projects, Chapter 3 provides formal notification of the new turbulence criterion and the removal of the long-standing vertical flow criterion.

The sixth edition has also been amended to include new ICAO SARPs relating to offshore helidecks and shipboard heliports, which generally become applicable from November 2009. This edition has also been revised to include material which is part of the fourth edition of the International Chamber of Shipping (ICS) Guide to Helicopter/Ship Operations, published in December 2008. For the first time, provisions are included for the design of winching area arrangements located on wind turbine platforms.

**Edition 6, Amendment 01/2010**

**April 2010**

This amendment was issued to provide operators with Additional Guidance Relating to the Provision of Meteorological Information from Offshore Installations. Editorial amendments convenient to be included at this time have also been incorporated.

**Edition 6, Amendment 02/2010**

**August 2010**

This amendment was issued to correct an error in Chapter 10, paragraph 2 that referred to a requirement for a medium intensity (rather than a low intensity) steady red obstruction light. The opportunity has been taken to update part of Chapter 4 relating to helideck lighting and part of Chapter 5 relating to the location of foam-making equipment. Editorial amendments convenient to be included at this time have also been incorporated.

**Edition 7**

**May 2012**

The seventh edition is revised to incorporate the full and final specification for the Helideck Lighting Scheme comprising Perimeter Lights, Lit Touchdown/Positioning Marking Circle and Lit Heliport Identification 'H' Marking.

The seventh edition has also been updated to reflect ICAO SARPs for Annex 14 Volume II due to become applicable for States from November 2013. Provisions for the design of winching area arrangements located on wind turbines, first introduced at the sixth edition, has been reviewed and updated to reflect current best practice with the benefit of lessons learned through various industry forums attended since 2008.

**Edition 7, Amendment 01/2013**

**February 2013**

This amendment was issued to clarify aspects of the final specification and installation arrangements for the Lit Touchdown/Positioning Marking Circle and Lit Heliport Identification Marking. Further amendments convenient to be included at this time have also been incorporated.

## Foreword

- 1 This publication, re-named Standards for Offshore Helicopter Landing Areas, has become an accepted world-wide source of reference. The amendments made to the seventh edition incorporate final results of valuable experience gained from the CAA-funded research project conducted with the support of the UK offshore industry and the UK Health and Safety Executive (HSE) into improved helideck lighting systems. In particular a final specification for the Touchdown/Positioning Marking (TD/PM) Circle and Heliport Identification ('H') Marking lighting system is presented in Appendix C, and referenced from Section 3 in Chapter 4. As a consequence of the introduction to service of new lighting systems, which the CAA - with the support of the Helicopter Task Group (established by Oil and Gas UK (OGUK)) - is recommending should be implemented on all existing and new-build installations operating on the UK Continental Shelf (UKCS), previous references to the use of deck-mounted floodlighting systems as an aid to landing have been relegated to Appendix material (see Appendix G). The CAA believes that the new lighting scheme fully described in the seventh edition represents a significant safety enhancement over traditional floodlighting and will take every opportunity to actively encourage the industry to deploy the new lighting scheme in preference to floodlighting. The TD/PM Circle and Heliport Identification ('H') Marking lighting forms an acceptable alternative to floodlights in International Civil Aviation Organization (ICAO) Annex 14 Volume II.

**NOTE:** It had been hoped that the first production version of the new lighting system would have been installed and evaluated in-service to ensure the availability of a viable system prior to publication of the seventh edition of CAP 437. Completion of the evaluation within that time frame is now in doubt, but it is considered that this is mainly due to issues with the trial's installation itself rather than the equipment or concept as a whole. The update to the corresponding material in CAP 437 has therefore been retained in order to provide the information and stimulus required to initiate equipment design and production, and planning for deployment. The CAA will be writing to the industry to advise its recommendations in respect of the retrofit of the new lighting system, in particular, in terms of timescales and prioritisation of helidecks. These recommendations will take due account of the status and results of the ongoing in-service evaluation of the first production version of the new lighting system.

- 2 At an international level the UK CAA continues to participate in the ICAO Heliport Design Working Group (HDWG) tasked with the substantial three-stage revision of Annex 14 Volume II including a review of the International Standards and Recommended Practices relating to offshore helidecks and shipboard heliports. The first tranche of material was formally approved by the ICAO Air Navigation Commission (ANC) in 2008 with an applicability to States from November 2009. CAP 437 addressed the agreed changes in December 2008, recognising their formal adoption into Annex 14 Volume II (third edition) in March 2009. A second tranche of amendment material was delivered to the Aerodromes Panel 2 meeting in October 2010 and following endorsement by the ANC was formally circulated in a State Letter dated 20 April 2011. ICAO has confirmed that the second tranche is now to be adopted in Annex 14 Volume II around March 2013 with applicability from 14 November 2013. CAP 437 incorporates the tranche two amendment so far as it addresses new Standards and Recommended Practices for helidecks and shipboard heliports.
- 3 Also at international level, the UK CAA participated in a technical group consisting of marine and aviation experts tasked with reviewing and updating the International Chamber of Shipping's (ICS) Guide to Helicopter/Ship Operations. A fourth edition of

the Guide was published in December 2008 and the current best practice from the ICS Guide was reflected in substantially revised Chapters 9 and 10 of the sixth edition of CAP 437. The UK CAA is grateful to the ICS for providing a number of new figures for these chapters.

- 4 In Europe, with the establishment and development of the European Aviation Safety Agency (EASA) the rulemaking function for States within the European Union is being transferred from the National Aviation Authorities (NAAs) to EASA in a phased transition which will see Requirements for Air Operators, enacted through Basic Regulation (EC) No. 216/2008, being transferred from State NAAs to EASA with effect from the fourth quarter of 2012. After this time holders of UK Air Operator's Certificates (AOCs) will be assessed for compliance with EASA Operational Requirements ("EASA Ops") and all certificates issued on the basis of the UK Air Navigation Order (ANO) or JAR-OPS 3 will be revoked. EASA Operational Requirements (EASA Ops), Annex IV Part-CAT, will address the use of aerodromes and operating sites by providing an acceptable means of compliance for authorising the use of aerodromes and operating sites in AMC material. This AMC material will be reproduced in future editions of CAP 437, Appendix A, but for the seventh edition of CAP 437 the AMC material established in JAR-OPS 3 is reproduced. In January 2014 the responsibility for the certification of aerodromes in member States is due to pass from the NAAs to EASA under Regulation (EC) No. 1108/2009 (amending Regulation 216/2008 in the field of aerodromes, air traffic management and air navigation services). It is not anticipated that helidecks and shipboard heliports will be covered by the scope of this Regulation, and so helidecks and shipboard heliports operating on the UKCS will continue to be regarded as unlicensed landing areas (see paragraph 6). CAP 437 presents the criteria required by the CAA in assessing the standards of offshore helicopter landing areas for world-wide use by helicopters registered in the UK. These landing areas may be located on:
  - fixed offshore installations;
  - mobile offshore installations;
  - vessels supporting offshore mineral exploitation; or
  - other vessels, e.g. tankers, cargo vessels, passenger vessels.
- 5 In this publication the term 'helideck' refers to all helicopter landing areas on fixed or floating offshore facilities used for the exploration or exploitation of oil and gas. For helicopter landing areas on vessels the term 'shipboard heliport' may be used in preference to 'helideck'.
- 6 The criteria described in CAP 437 form part of the requirements issued by the CAA to UK helicopter operators which is to be accounted for in Operations Manuals required under UK aviation legislation in JAR-OPS 3 and in future by EASA's Operational Requirements (EASA Ops). Helidecks on the UKCS are regarded as 'unlicensed landing areas' and offshore helicopter operators are required to satisfy themselves that each helideck to which they operate is fit for purpose. The helicopter operators have chosen to discharge the legal responsibility placed on them by accepting Helicopter Landing Area Certificates (HLACs) as a product of helideck inspections completed by the Helideck Certification Agency (HCA) (see Glossary of Terms). The HCA, acting for the interests of the offshore helicopter operators, provides the single focal point for helideck matters in the UK to ensure that a level playing field is maintained between the operators. The operators have each given an undertaking to use the HCA system of authorisation by agreeing a Memorandum of Understanding (MoU) and by publishing relevant material in their company Operations Manuals.



- 7 If an offshore helideck does not meet the criteria in CAP 437, or if a change to the helideck environment is proposed, the case should be referred to the HCA in the first instance to enable them to collate information on behalf of the helicopter operators so that the process for authorising the use of the helideck can be completed in a timely fashion. Early consultation with the HCA is essential if maximum helicopter operational flexibility is to be realised and incorporated into the installation design philosophy. It is important that changes are not restricted to consideration of the physical characteristics and obstacle protected surfaces of the helideck. Of equal, and sometimes even more, importance are changes to the installation or vessel, and to adjacent installation or vessel structures which may affect the local atmospheric environment over the helideck (and adjacent helidecks) or approach and take-off paths. In the case of 'new-builds' or major modifications to existing Installations that may have an effect on helicopter operations, the CAA has published guidance on helideck design considerations in CAA Paper 2008/03, which is available to assist with the interpretation and the application of criteria stated in CAP 437.
- 8 This procedure described for authorising the use of helidecks on fixed and floating installations operating on the UKCS is co-ordinated by the HCA in a process which involves OGUK; the British Rig Owners' Association (BROA); and the International Association of Drilling Contractors (IADC) members' individual owner/operator safety management systems.
- 9 The HCA assumes the role of Chairman for the Helideck Steering Committee which includes senior operational flying staff from all the offshore helicopter operators. The Helideck Steering Committee functions to ensure that commonality is achieved between the offshore helicopter operators in the development and application of operational polices and limitations and that non-compliances, where identified, are treated in a consistent manner by each operator. The HCA publishes the Helideck Limitations List (HLL) which contains details of known helidecks including any operator-agreed limitations applied to specific helidecks in order to compensate for any failings or deficiencies in meeting CAP 437 criteria such that the safety of flights is not compromised.
- 10 Although the process described above is an industry-agreed system, the legal responsibility for acceptance of the safety of offshore helicopter landing sites rests ultimately with the helicopter operators. The CAA accepts the process described above as being an acceptable way in which the assessment of the CAP 437 criteria can be made. The CAA, in discharging its regulatory responsibility, will audit the application of the process on which the helicopter operator relies. As part of the oversight of the AOC holder, the CAA may review and audit HCA procedures and processes to assess how they assist the legal responsibilities and requirements of the offshore helicopter operators.
- 11 The criteria in this publication relating to fixed and mobile installations in the area of the UKCS provide standards which are accepted by the HSE and referred to in HSE offshore legislation. The criteria address **minimum** standards required in order to achieve a clearance which will attract no helicopter performance (payload) limitations. CAP 437 is an amplification of internationally agreed standards contained in ICAO Annex 14 to the Convention on International Civil Aviation, Volume II, 'Heliports'. Additionally it provides advice on 'best practice' obtained from many aviation sources. 'Best practice', naturally, should be moving forward continuously and it should be borne in mind that CAP 437 reflects 'current' best practice at the time of publication. There may be alternative equivalent means of meeting the criteria presented in CAP 437 and these will be considered on their merits.

- 12 Additional criteria are given relating to vessels used in support of offshore mineral exploitation which are not necessarily subject to HSE offshore regulation and also for other vessels such as tanker, cargo and passenger vessels.
- 13 Whenever the term 'CAA' is used in this publication, it means the UK Civil Aviation Authority unless otherwise indicated.
- 14 As standards for best practice, this document applies the term "should" when referring to either an ICAO Standard or a Recommended Practice. The term "may" is used when a variation or alternative approach could be acceptable to the CAA. The UK HSE accepts that conformance with CAP 437 will demonstrate compliance with applicable offshore regulations. CAP 437 is under continuous review resulting from technological developments and experience; comments are always welcome on its application in practice. The CAA should be contacted on matters relating to interpretation and applicability of these standards and Aviation Law.

## Glossary of Terms and Abbreviations

AAIB	Air Accidents Investigation Branch.
AMSL	Above Mean Sea Level.
ANC	Air Navigation Commission.
ANO	The Air Navigation Order.
AOC	Air Operator's Certificate.
CAFS	Compressed Air Foam System.
CFD	Computational Fluid Dynamics.
Class Societies	Organisations that establish and apply technical standards to the design and construction of marine facilities including ships.
D-circle	A circle, usually hypothetical unless the helideck itself is circular, the diameter of which is the D-value of the largest helicopter the helideck is intended to serve.
D-value	The largest overall dimension of the helicopter when rotors are turning. This dimension will normally be measured from the most forward position of the main rotor tip path plane to the most rearward position of the tail rotor tip path plane (or the most rearward extension of the fuselage in the case of Fenestron or Notar tails).
DIFFS	Deck Integrated Fire Fighting System(s).
DSV	Diving Support Vessel.
EASA	European Aviation Safety Agency.
Falling 5:1 Gradient	A surface extending downwards on a gradient of 5:1 measured from the edge of the safety netting located around the landing area below the elevation of the helideck to water level for an arc of not less than 180° that passes through the centre of the landing area and outwards to a distance that will allow for safe clearance from obstacles below the helideck in the event of an engine failure for the type of helicopter the helideck is intended to serve. For helicopters operated in Performance Class 1 or 2 the horizontal extent of this distance will be compatible with the one-engine inoperative capability of the helicopter type to be used.
FMS	Fixed Monitor System.
FOD	Foreign Object Debris/Damage.
FPSO	Floating Production Storage and Offloading units.
FSU	Floating Storage Unit.

---

HCA	Helideck Certification Agency (formerly known as BHAB Helidecks). The HCA is the certifying agency acting on behalf of the UK offshore helicopter operators that audits and inspects all helidecks and shipboard heliports on offshore installations and vessels operating in UK waters to the standards laid down in CAP 437.
HDWG	Helicopter Design Working Group (of ICAO Aerodromes panel).
Helideck	A helicopter landing area located on a fixed or floating offshore facility.
HHOP	Helicopter Hoist Operations Passengers.
HLAC	The Helicopter Landing Area Certificate issued by the HCA, and required by UK offshore helicopters operators, to authorise the use of a helideck or shipboard heliport.
HLL	Helideck Limitations List (formerly known as the Installation/Vessel Limitation List (IVLL)). Published and distributed by the HCA in UKCS <b>or</b> other National Authority accepted bodies in other European States.
HLO	Helicopter Landing Officer.
HMS	Helideck Motion System.
HSC	Health and Safety Commission.
HSE	Health and Safety Executive.
IATA	International Air Transport Association.
ICAO	International Civil Aviation Organization.
ICP	Independent and competent person as defined in the Offshore Installations (Safety Case) Regulations 2005 who is selected to perform functions under the verification scheme.
ICS	International Chamber of Shipping.
IMO	International Maritime Organization.
ISO	International Organization for Standardization.
JIG	Joint Inspection Group.
Landing Area	A generic term referring to the load-bearing area primarily intended for the landing and take-off of aircraft. The area, sometimes referred to as the Final Approach and Take-Off area (FATO), is bounded by the perimeter line and perimeter lighting.
LED	Light Emitting Diode.
LFL	Lower Flammable Limit.
LOS	Limited Obstacle Sector(s). The 150° sector within which obstacles may be permitted, provided the height of the obstacles is limited.
MEK	Methyl Ethyl Ketone.
MSI	Motion Severity Index.
MTOM	Maximum Certificated Take-Off Mass.

NAA	National Aviation Authority.
NAI	Normally Attended Installation.
NDB	Non-Directional Beacon.
NM	Nautical Mile(s).
NUI	Normally Unattended Installation.
OFS	Obstacle Free Sector. The 210° sector, extending outwards to a distance that will allow for an unobstructed departure path appropriate to the helicopter the helideck is intended to serve, within which no obstacles above helideck level are permitted. For helicopters operated in Performance Class 1 or 2 the horizontal extent of this distance will be compatible with the one-engine inoperative capability of the helicopter type to be used.
OGUK	Oil and Gas UK (formerly known as the United Kingdom Offshore Operators Association (UKOOA)).
OIAC	Offshore Industry Advisory Committee.
OIAC-HLG	Offshore Industry Advisory Committee – Helicopter Liaison Group.
OIS	Offshore Information Sheet.
PAI	Permanently Attended Installation (same as NAI).
PCF	Post-Crash Fire.
Perimeter D Marking	The marking located in the perimeter line in whole numbers; i.e. the D-value (see above) rounded up or down to the nearest whole number.
PPE	Personal Protective Equipment.
RD	Rotor Diameter.
RFF	Rescue and Fire Fighting.
RFFS	Rescue and Fire-Fighting Services.
RMS	Ring-Main System (as an alternative to DIFFS or FMS on an existing installation).
Run-Off Area	An extension to the Landing Area designed to accommodate a parked helicopter; sometimes referred to as the Parking Area.
SASF	Southern Aviation Safety Forum.
Shipboard Heliport	A heliport located on a vessel which may be purpose-built or non-purpose-built.
SHR	Significant Heave Rate.

---

TD/PM Circle	<p>Touchdown/Positioning Marking Circle. Described as the Aiming Circle in earlier editions of CAP 437, the TD/PM Circle is the aiming point for a normal touchdown (landing) so located that when the pilot's seat is over the marking, the whole of the undercarriage will be within the landing area and all parts of the helicopter will be clear of any obstacles by a safe margin.</p> <p><b>Note:</b> It should be noted that only correct positioning over the TD/PM Circle will ensure proper clearance with respect to physical obstacles and provision of ground effect and provision of adequate passenger access/egress.</p>
UKCS	UK Continental Shelf (Geographical area).
UPS	Uninterrupted Power Supply.
Verification Scheme	A suitable written scheme as defined in the Offshore Installations (Safety Case) Regulations 2005 for ensuring the suitability and proper maintenance of safety-Critical Elements (SCEs).
VMC	Visual Meteorological Conditions
WMO	World Meteorological Organization.
WSI	Wind Severity Index.

# Chapter 1 Introduction

## 1 History of Development of Criteria for Offshore Helicopter Landing Areas, 1964-1973

- 1.1 In the early 1960s it became apparent that there would be a continuing requirement for helicopter operations to take place on fixed and mobile offshore installations. Various ideas were put forward by oil companies and helicopter operators as to the appropriate landing area standards for such operations. In 1964, draft criteria were published which used helicopter rotor diameter as a determinant of landing area size and associated obstacle-free area. In the light of experience and after further discussions, the criteria were amended and re-published in 1968. These criteria were then, and still are, based upon helicopter overall length (from the most forward position of main rotor tip to the most rearward position of tail rotor tip plane path, or rearmost extension of the fuselage in the case of fenestron or Notar tails). This length is commonly referred to as 'D' for any particular helicopter as the determinant of landing area size, associated characteristics, and obstacle-protected surfaces.

## 2 Department of Energy and the Health and Safety Executive Guidance on the Design and Construction of Offshore Installations, 1973 Onwards

- 2.1 In the early 1970s, the Department of Energy began the process of collating guidance standards for the design and construction of 'installations' – both fixed and mobile. This led to the promulgation of the Offshore Installations (Construction and Survey Regulations) 1974, which were accompanied by an amplifying document entitled 'Offshore Installations: Guidance on the design and construction of offshore installations' (the 4th Edition Guidance). This guidance included criteria for helicopter landing areas which had been slightly amended from those issued in 1968. During 1976 and 1977, the landing area criteria were developed even further during a full-scale revision of this document, following consultations between the CAA, the British Helicopter Advisory Board and others. This material was eventually published in November 1977 and amended further in 1979. This latter amendment introduced the marking of the landing area to show the datum from which the obstacle-free area originated, the boundary of the area, and the maximum overall length of helicopter for which operations to the particular landing area were suitable. The first edition of CAP 437 was published in 1981, amended in 1983 and revised in December 1993 (second edition) and October 1998 (third edition). Following a further amendment in January 2001, a fourth edition of CAP 437, incorporating the new house style, was placed on the Publications section of the CAA website at [www.caa.co.uk](http://www.caa.co.uk) in September 2002. This was superseded by the fifth edition of CAP 437 in August 2005 and a sixth edition in December 2008. Since the early 1990s changes have been introduced which incorporate the results of valuable experience gained from various 'helideck' research programmes as well as useful feedback gleaned from an ongoing inspection and certification process; changes also include the latest helideck criteria internationally agreed and published as Volume II (Heliports) of Annex 14 to the Convention on International Civil Aviation. A further amendment to Annex 14 Volume II is expected to be adopted early in 2013 (with applicability from 14 November 2013); and the latest helideck and shipboard heliport criteria generated by the forthcoming ICAO amendment is reflected, in advance of ICAO implementation, in this seventh edition of CAP 437.

- 2.2 In April 1991 the Health and Safety Commission (HSC) and the HSE took over from the Department of Energy the responsibility for offshore safety regulation. The Offshore Safety Act 1992, implementing the Cullen recommendations following the Piper Alpha disaster, transferred power to the HSE on a statutory footing. The HSE also took over sponsorship of the 4th Edition and Section 55 'Helicopter landing areas' referring to all installations.
- 2.3 Since April 1991, the HSE has introduced four sets of modern goal-setting regulations which contain provisions relating to helicopter movements and helideck safety on offshore installations. These update and replace the old prescriptive legislation. The provisions are as follows:

	<b>Regulations</b>	<b>Covers</b>
1.	The Offshore Installations (Safety Case) Regulations 2005 (SCR) (SI 2005/3117)	<b>Regulation 2(1)</b> defines a major accident and this includes the collision of a helicopter with an installation. <b>Regulation 2(1)</b> defines safety-critical elements (SCEs) and <b>Regulation 2(5)</b> refers to a verification scheme for ensuring by means described in <b>Regulation 2(6)</b> that the SCEs will be suitable and remain in good repair and condition. Helidecks and their associated systems are deemed to be SCEs. <b>Regulation 6</b> requires the submission of a design notification containing the particulars specified in Schedule 1. <b>Regulation 12(1)</b> requires that a safety case should demonstrate: the adequacy of the safety management system to ensure compliance with relevant statutory provisions; the adequacy of arrangements for audit; that all hazards with the potential to cause a major accident have been identified and evaluated; and that measures have been taken to ensure that the relevant statutory provisions will be complied with.
2.	The Offshore Installations (Prevention of Fire and Explosion, and Emergency Response) Regulations 1995 (PFEER) (SI 1995/743)	<b>Regulation 6(1)(c)</b> requires a sufficient number of personnel trained to deal with helicopter emergencies to be available during helicopter movements. <b>Regulation 7</b> requires the operator/owner of a fixed/mobile installation to ensure that equipment necessary for use in the event of an accident involving a helicopter is kept available near the helicopter landing area. Equipment provided under <b>Regulation 7</b> must comply with the suitability and condition requirements of <b>Regulation 19(1)</b> of PFEER. <b>Regulations 9, 12</b> and <b>13</b> make general requirements for the prevention of fire and explosion, the control of fire and explosion which would take in helicopter accidents. <b>Regulation 17</b> of PFEER requires arrangements to be made for the rescue of people near the installation from helicopter ditchings.



3.	The Offshore Installations and Pipeline Works (Management and Administration) Regulations 1995 (MAR) (SI 1995/738)	<p><b>Regulation 8</b> requires people to co-operate with the Helicopter Landing Officer to enable him to perform his function referred to in <b>Regulation 13</b>. <b>Regulation 11</b> requires comprehensible instructions to be put in writing and brought to the attention of everybody to whom they relate. Circumstances where written instructions might be needed include helideck operations (particularly if involving part-time helideck crew). <b>Regulation 12(b)</b> requires arrangements which are appropriate for health and safety purposes to be in place for effective communication between an installation, the shore, aircraft and other installations. Arrangements must also be in place for effective communication where a helicopter is to land on or take off from an installation aboard which there will be no person immediately before landing or after the take-off, and between the helicopter and a suitable offshore installation with persons on board or, where there is no suitable installation, suitable premises ashore. <b>Regulation 13</b> requires the operator/owner of a fixed/mobile installation to ensure that a competent person is appointed to be in control of helideck operations on the installation (i.e. the Helicopter Landing Officer (HLO)), is present on the installation and is in control throughout such operations, and procedures are established and plant provided as will secure so far as is reasonably practicable that helideck operations including landing/take-off are without risks to health and safety. <b>Regulation 14</b> requires the duty holder to make arrangements for the collection and keeping of meteorological and oceanographic information and information relating to the movement of the offshore installation. This is because environmental conditions may affect helicopter operations and the ability to implement emergency plans. <b>Regulation 19</b> requires the operator/owner of an offshore installation to ensure that the installation displayed its name in such a manner as to make the installation readily identifiable by sea or air; and displays no name, letters or figures likely to be confused with the name or other designation of another offshore installation.</p>
----	--------------------------------------------------------------------------------------------------------------------	------------------------------------------------------------------------------------------------------------------------------------------------------------------------------------------------------------------------------------------------------------------------------------------------------------------------------------------------------------------------------------------------------------------------------------------------------------------------------------------------------------------------------------------------------------------------------------------------------------------------------------------------------------------------------------------------------------------------------------------------------------------------------------------------------------------------------------------------------------------------------------------------------------------------------------------------------------------------------------------------------------------------------------------------------------------------------------------------------------------------------------------------------------------------------------------------------------------------------------------------------------------------------------------------------------------------------------------------------------------------------------------------------------------------------------------------------------------------------------------------------------------------------------------------------------------------------------------------------------------------------------------------------------------------------------------------------------------------------------------------------------------------------------------------------------------------------------------------------------------------------------------------------------------------------------------------------------------------------------------------------------------------------------------------------------------------------------------------------------------------------------------------------------------------------------------------------------------------------------------------------------------------------------------------------

4.	The Offshore Installations and Wells (Design and Construction, etc.) Regulations 1996 (DCR) (SI 1996/913)	<b>Regulation 11</b> – Helicopter Landing Area requires the operator/owner of a fixed/mobile installation to ensure that every landing area forming part of an installation is large enough, and has sufficient clear approach/departure paths, to enable any helicopter intended to use the landing area safely to land and take off in any wind and weather conditions permitting helicopter operations, and is of a design and construction adequate for its purpose.
The HSE has published guidance documents on SCR, MAR and DCR and, in the case of PFEER, combined guidance and an Approved Code of Practice.		

- 2.4 In February 2005 UKOOA (now OGUK) published “Guidelines for the Management of Offshore Helideck Operations” (Issue 5) preceded in 2004 by an HSE publication “Offshore Helideck Design Guidelines” which was sponsored by the HSE and the CAA, and endorsed by the Offshore Industry Advisory Committee – Helicopter Liaison Group (OIAC-HLG). The UKOOA ‘Guidelines’ have now been superseded by the Oil and Gas UK “Guidelines for the Management of Aviation Operations” (Issue 6, April 2011). When referring to the “Offshore Helideck Design Guidelines” it is the responsibility of the reader to ensure that no conflict exists with the seventh edition of CAP 437. Where potential differences arise the current best practice in CAP 437 should always take precedence. Where doubt exists, the reader is advised to seek guidance from CAA Flight Operations Inspectorate (Helicopters) Section.

### 3 Applicability of Standards in Other Cases

- 3.1 For vessels engaged in supporting mineral exploitation (such as crane or derrick barges, pipe-laying vessels, diving support vessels, seismic research vessels, etc.), which are not classed as ‘offshore installations’ and so are not subject to a verification scheme, the CAA recommends the application of the same standards for the helicopter landing areas as contained in this CAP. Compliance with this recommendation will enable helicopter operators to fulfil their own legal obligations and responsibilities.
- 3.2 On other merchant vessels where it is impracticable for these standards to be achieved, for example where the landing area has to be located amidships or is non-purpose-built on a ship’s side, the criteria to be used are included in Chapter 9 of this publication. Criteria for helicopter winching areas on ships and on wind turbines is included in Chapter 10. Whilst this material covers the main aspects of criteria for a helicopter landing or manoeuvring area, there may be operational factors involved with vessels such as air turbulence; flue gases; excessive helideck motion; or the size of restricted amidships landing areas, on which guidance should be obtained from the helicopter operator or the agency responsible for certification of the helideck or from other competent specialists.

### 4 Worldwide Application

- 4.1 It should be noted that references are made to United Kingdom legislative and advisory bodies. However, this document is written so that it may provide minimum standards applicable for the safe operation of helicopters to offshore helidecks throughout the world.

- 4.2 CAP 437 is therefore particularly relevant to UK (G) registered helicopters operating within and outside the UKCS areas; whether or not they have access to the UK authorisation process. In cases where the UK authorisation process is not applicable or available, helicopter operators should have in place a system for assessing and authorising the operational use of each helideck. Within Europe, through Joint Aviation Requirements JAR-OPS 3, authorisation of each helideck is a specific requirement laid down in Subpart D, JAR-OPS 3.220 and guidance on the criteria for assessment is given in an 'acceptable means of compliance' (AMC) to this requirement (AMC No. 2 to OPS 3.220 'Authorisation of Heliports by the operator – Helidecks' - reproduced in CAP 437, Appendix A). Throughout the range of operations covered by Part-CAT, agreement has been made to share all helideck information between helicopter operators by the fastest possible means.
- 4.3 Other helicopter operators, who operate outside the areas covered by JAR-OPS 3 and who are using this document, are recommended to establish a system for assessing and authorising each helideck for operational use. It is a fact that many installations and vessels do not fully comply with the criteria contained in the following chapters. A system for the assessment of the level of compliance, with processes and procedures for the management of rectification actions (where practicable) plus a system for imposing compensating operational limitations (where rectification actions are impractical), is often the only fail-safe way of ensuring that the level of safety to flights is not compromised.

INTENTIONALLY LEFT BLANK

# Chapter 2 Helicopter Performance Considerations

## 1 General Considerations

- 1.1 The criteria for helicopter landing areas on offshore installations and vessels result from the need to ensure that UK registered helicopters are afforded sufficient space to be able to operate safely at all times in the varying conditions experienced offshore.
- 1.2 The helicopter's performance requirements and handling techniques are contained in the Rotorcraft Flight Manual and/or the operator's Operations Manual.
- 1.3 Helicopter companies operating for public transport are required to hold an AOC which is neither granted nor allowed to remain in force unless they provide procedures for helicopter crews which safely combine the space and performance requirements mentioned above.

## 2 Safety Philosophy

- 2.1 Aircraft performance data is scheduled in the Flight Manual and/or the Operations Manual which enables flight crew to accommodate the varying ambient conditions and operate in such a way that the helicopter has sufficient space and sufficient engine performance to approach, land on and take off from helidecks in safety.
- 2.2 Additionally, Operations Manuals recognise the remote possibility of a single engine failure in flight and state the flying procedures and performance criteria which are designed to minimise the exposure time of the aircraft and its occupants during the short critical periods during the initial stage of take-off, or final stage of landing.

## 3 Factors Affecting Performance Capability

- 3.1 On any given day helicopter performance is a function of many factors including the actual all-up mass; ambient temperature; pressure altitude; effective wind speed component; and operating technique. Other factors, concerning the physical and airflow characteristics of the helideck and associated or adjacent structures, will also combine to affect the length of the exposure period referred to in paragraph 2.2. These factors are taken into account in the determination of specific and general limitations which may be imposed in order to ensure adequate performance and to ensure that the exposure period is kept to a minimum. In many circumstances the period will be zero. It should be noted that, following a rare power unit failure, it may be necessary for the helicopter to descend below deck level to gain sufficient speed to safely fly away, or in extremely rare circumstances to land on the water. In certain circumstances, where exposure periods would otherwise be unacceptably long, it will probably be necessary to reduce helicopter mass (and therefore payload) or even to suspend flying operations.

INTENTIONALLY LEFT BLANK

# Chapter 3 Helicopter Landing Areas – Physical Characteristics

## 1 General

- 1.1 This chapter provides criteria on the physical characteristics of helicopter landing areas (helidecks) on offshore installations and some vessels. It should be noted that where a Verification Scheme is required it should state for each helicopter landing area the maximum size of helicopter in terms of D-value and the mass for which that area is verified with regard to its size and strength. Where the criteria cannot be met in full for a particular type of helicopter it may be necessary to promulgate operational restrictions in order to compensate for deviations from these criteria. The helicopter operators are notified of any restrictions through the HLL.
- 1.2 The criteria which follow are based on helicopter size and mass. This data is summarised in Table 1 below.

**Table 1** D-Value, 't' Value and other Helicopter Type Criteria

Type	D-value (metres)	Perimeter 'D' marking	Rotor diameter (metres)	Max weight (kg)	't' value	Landing net size
Bolkow Bo 105D	12.00	12	9.90	2400	2.4t	Not recommended
EC 135 T2+	12.20	12	10.20	2910	2.9t	Not recommended
Bolkow 117	13.00	13	11.00	3200	3.2t	Not recommended
Agusta A109	13.05	13	11.00	2600	2.6t	Small
Dauphin AS365 N2	13.68	14	11.93	4250	4.3t	Small
Dauphin AS365 N3	13.73	14	11.94	4300	4.3t	Small
EC 155B1	14.30	14	12.60	4850	4.9t	Medium
Sikorsky S76	16.00	16	13.40	5307	5.3t	Medium
Agusta/Westland AW 139	16.63	17	13.80	6800	6.8t	Medium
Bell 412	17.13	17	14.02	5397	5.4t	Not recommended
Bell 212	17.46	17	14.63	5080	5.1t	Not recommended
Super Puma AS332L	18.70	19	15.60	8599	8.6t	Medium
Bell 214ST	18.95	19	15.85	7938	7.9t	Medium
Super Puma AS332L2	19.50	20	16.20	9300	9.3t	Medium
EC 225	19.50	20	16.20	11000	11.0t	Medium
Sikorsky S92A <sup>1</sup>	20.88	21	17.17	12020	12.0t	Large
Sikorsky S61N	22.20	22	18.90	9298	9.3t	Large
EH101	22.80	23	18.60	14600	14.6t	Large

1. Manufacturer derived data has indicated that the Maximum Certificated Take-Off Mass (MTOM) of the S92A may grow to 12,565 kg. It is understood that structural design considerations for new-build S92 helidecks will normally be based on the higher take-off mass (12,565 kg). Where structural design is verified by an ICP to be in accordance with the 'growth' take-off mass, duty holders are permitted to display the higher 't' value marking on the helideck, i.e. '12.6t'.

**NOTE:** Where skid-fitted helicopters are used routinely, landing nets are not recommended.

## 2 Helideck Design Considerations – Environmental Effects

### 2.1 Introduction

2.1.1 The safety of helicopter flight operations can be seriously degraded by environmental effects that may be present around installations or vessels and their helidecks. The term “environmental effects” is used here to represent the effects of the installation or vessel and/or its systems and/or processes on the surrounding environment, which result in a degraded local environment in which the helicopter is expected to operate. These environmental effects are typified by structure-induced turbulence, turbulence and thermal effects caused by gas turbine exhausts, thermal effects of flares and diesel exhaust emissions, and unburnt hydrocarbon gas emissions from cold flaring or, more particularly, emergency blow-down systems. It is almost inevitable that helidecks installed on the cramped topsides of offshore installations will suffer to some degree from one or more of these environmental effects, and controls in the form of operational restrictions may be necessary in some cases. Such restrictions can be minimised by careful attention to the design and layout of the installation topsides and, in particular, the location of the helideck.

2.1.2 Advice on the design and placement of offshore helidecks is provided in this document, and includes certain environmental criteria (see paragraph 2.2.1). These criteria have been set to define safe operating boundaries for helicopters in the presence of known environmental hazards. Where these criteria cannot be met, a limitation is placed in the HLL. These entries are usually specific to particular combinations of wind speed and direction, and either restrict helicopter mass (payload), or prevent flying altogether in certain conditions.

2.1.3 The HLL system is operated for the benefit of the offshore helicopter operators and should ensure that landings on offshore helidecks are properly controlled when adverse environmental effects are present. On poorly designed helidecks, severe operational restrictions may result, leading to significant commercial penalties for an installation operator or vessel owner. Well designed and ‘helicopter friendly’ platform topsides and helidecks should result in efficient operations and cost savings for the installation operator.

**NOTE:** It is important that the helicopter operators through the agency responsible for the certification of the helideck are always consulted at the earliest stage of design to enable them to provide advice and information so that the process for authorising the use of the helideck can be completed in a timely fashion and in a manner which ensures that maximum helicopter operational flexibility is realised. Information from helideck flow assessment studies (see paragraphs 2.3.2 and 2.3.3) should be made available to the helicopter operators as early as possible to enable them to identify any potential adverse environmental effects that may impinge on helicopter flight operations and which, if not addressed at the design stage, could lead to operational limitations being imposed to ensure that safety is not compromised.

### 2.2 Helideck Design Guidance

2.2.1 A review of offshore helideck environmental issues (see CAA Paper 99004) concluded that many of the decisions leading to poor helideck operability had been made in the very early stages of design, and recommended that it would be easier for designers to avoid these pitfalls if comprehensive helideck design guidance was made available to run in parallel with CAP 437. As part of the subsequent research programme, material covering environmental effects on offshore helideck operations was commissioned by the HSE and the CAA. This material is now presented in CAA Paper 2008/03: “Helideck Design Considerations – Environmental Effects” and is available on the Publications section of the CAA website at [www.caa.co.uk/](http://www.caa.co.uk/)



publications. It is strongly recommended that platform designers and offshore duty holders consult CAA Paper 2008/03 at the earliest possible stage of the design process.

- 2.2.2 The objective of CAA Paper 2008/03 is to help platform designers to create offshore installation topside designs and helideck locations that are safe and 'friendly' to helicopter operations by minimising exposure to environmental effects. It is hoped that, if used from 'day one' of the offshore installation design process when facilities are first being laid out, this manual will prevent or minimise many helideck environmental problems at little or no extra cost to the design or construction of the installation. See also HSE Offshore Information sheet (OIS) No. 5/2011, issued June 2011.

## 2.3 Design Criteria

- 2.3.1 The design criteria given in the following paragraphs represent the current best information available and should be applied to new installations, to significant modifications to existing installations, and to combined operations (where a mobile platform or vessel is operating in close proximity to another installation). In the case of multiple platform configurations, the design criteria should be applied to the arrangement as a whole.

**NOTE:** When considering the volume of airspace to which the following criteria apply, installation designers should consider the airspace up to a height above helideck level which takes into consideration the requirement to accommodate helicopter landing and take-off decision points or committal points. This is deemed to be up to a height above the helideck corresponding to 30 ft plus wheels-to-rotor height plus one rotor diameter.

- 2.3.2 All new-build offshore helidecks, modifications to existing topside arrangements which could potentially have an effect on the environmental conditions around an existing helideck, or helidecks where operational experience has highlighted potential airflow problems should be subject to appropriate wind tunnel testing or Computational Fluid Dynamics (CFD) studies to establish the wind environment in which helicopters will be expected to operate. As a general rule, a limit on the standard deviation of the vertical airflow velocity of 1.75 m/s should not be exceeded. The helicopter operator should be informed at the earliest opportunity of any wind conditions for which this criterion is not met. Operational restrictions may be necessary.

**NOTES:** 1. Following completion of the validation exercise, the provisional limit on the standard deviation of the vertical airflow velocity of 2.4 m/s specified in CAP 437 fifth edition was lowered to 1.75 m/s. This change was made to allow for flight in reduced cueing conditions, for the less able or experienced pilot, and to better align the associated measure of pilot workload with operations experience. It is recommended that use is made of the helicopter operators' existing operations monitoring programmes to include the routine monitoring of pilot workload and that this be used to continuously inform and enhance the quality of the HLL entries for each platform (see CAA Paper 2008/02 – Validation of the Helicopter Turbulence Criterion for Operations to Offshore Platforms).

2. Following the establishment of the new turbulence criterion for helicopters operating to offshore installations, the need for retention of the long-standing CAP 437 criterion related to a vertical wind component of 0.9 m/s has been reviewed. As it has not been possible to link the criterion to any helicopter performance (i.e. torque related) or handling (pilot work related) hazard, it is considered that the vertical mean wind speed criterion can be removed from CAP 437. The basis for the removal from CAP 437 is described in detail in CAA Paper 2008/02 Study II – A Review of 0.9 m/s Vertical Wind Component Criterion for Helicopters Operating to Offshore Installations.

- 2.3.3 Unless there are no significant heat sources on the installation or vessel, offshore duty holders should commission a survey of ambient temperature rise based on a Gaussian dispersion model and supported by wind tunnel tests or CFD studies for new-build helidecks, for significant modifications to existing topside arrangements, or for helidecks where operational experience has highlighted potential thermal problems. When the results of such modelling and/or testing indicate that there may be a rise of air temperature of more than 2°C (averaged over a three-second time interval), the helicopter operator should be consulted at the earliest opportunity so that appropriate operational restrictions may be applied.
- 2.3.4 Previous editions of CAP 437 have suggested that 'some form of exhaust plume indication should be provided for use during helicopter operations, for example, by the production of coloured smoke'. Research has been conducted into the visualisation of gas turbine exhaust plumes and guidance on how this can be achieved in practice has been established. This work is now reported in CAA Paper 2007/02 which recommends that consideration should be given to installing a gas turbine exhaust plume visualisation system on platforms having a significant gas turbine exhaust plume problem in order to highlight the hazards to pilots and thereby minimising its effects by making it easier to avoid encountering the plume. It is further recommended that use is made of the helicopter operators' existing operations monitoring programmes to establish and continuously monitor the temperature environments around all offshore platforms. This action is aimed at identifying any 'problem' platforms, supporting and improving the contents of the HLL, identifying any new problems caused by changes to platform topsides or resulting from combined operations, and identifying any issues related to flight crew training or procedures.
- 2.3.5 The maximum permissible concentration of hydrocarbon gas within the helicopter operating area is 10% Lower Flammable Limit (LFL). Concentrations above 10% LFL have the potential to cause helicopter engines to surge and/or flame out with the consequent risk to the helicopter and its passengers. It should also be appreciated that, in forming a potential source of ignition for flammable gas, the helicopter can pose a risk to the installation itself. It is considered unlikely that routine 'cold flaring' will present any significant risk, but the operation of emergency blow-down systems should be assumed to result in excessive gas concentrations. Installation operators should have in place a management system which ensures that all helicopters in the vicinity of any such releases are immediately advised to stay clear.
- NOTE:** The installation of 'Status Lights' systems (see Chapter 4, paragraph 3.6) is not considered to be a solution to all potential flight safety issues arising from hydrocarbon gas emissions; these lights are only a visual warning that the helideck is in an unsafe condition for helicopter operations.
- 2.3.6 For 'permanent' multiple platform configurations, usually consisting of two or more bridge-linked fixed platforms in close proximity, where there is a physical separation of the helideck from the production and process operation, the environmental effects of hazards emanating from the 'remote' production platform should be considered on helideck operations. This is particularly appropriate for the case of hot or cold gas exhausts where there will always be a wind direction that carries any exhaust plumes from a neighbouring platform (bridge-linked module) in the direction of the helideck.

- 2.3.7 For 'temporary' combined operations, where one mobile installation or vessel (e.g. a flotel) is operated in close proximity to a fixed installation, the environmental effects of hazards emanating from one installation (or vessel) on the other installation (or vessel) should be fully considered. This 'assessment' should consider the effect of the turbulent wake from one platform impinging on the helideck of the other, and of any hot or cold gas exhausts from one installation or vessel influencing the approach to the other helideck. On occasions there may be more than two installations and/or vessels in a 'temporary combined' arrangement. Where this is the case, the effect of turbulent wake and hot gas exhausts from each installation or vessel on all helideck operations within the combined arrangement should be considered.

**NOTE:** Paragraph 2.3 is primarily concerned with the issue of environmental effects on the helideck design. In respect of permanent multi-platform configurations and 'temporary' combined operations there are a number of other considerations that may need to be addressed. These include, but may not be limited to, the effect of temporary combined operations on helideck obstacle protection criteria. Additional considerations are described in more detail in the OGUK 'Guidelines for the Management of Aviation Operations'.

### 3 Structural Design

- 3.1 The take-off and landing area should be designed for the heaviest and largest helicopter anticipated to use the facility (see Table 1). Helideck structures should be designed in accordance with relevant International Organization for Standardization (ISO) codes for offshore structures and for floating installations. The maximum size and mass of helicopters for which the helideck has been designed should be stated in the Installation/Vessel Operations Manual and Verification and/or Classification document.
- 3.2 Optimal operational flexibility may be gained from considering the potential life and usage of the facility along with likely future developments in helicopter design and technology.
- 3.3 Consideration should also be given in the design to other types of loading such as personnel, other traffic, snow and ice, freight, refuelling equipment, rotor downwash etc. as stated in the relevant ISO codes. It may be assumed that single main rotor helicopters will land on the wheel or wheels of two landing gear (or both skids if fitted). The resulting loads should be distributed between two main undercarriages. Where advantageous a tyre contact area may be assumed in accordance with the manufacturer's specification. Ultimate limit state methods may be used for the design of the helideck structure, including girders, trusses, pillars, columns, plating and stiffeners. A serviceability limit check should also be performed to confirm that the maximum deflection of the helideck under maximum load is within code limits. This check is intended to reduce the likelihood of the helideck structure being so damaged during an emergency incident as to prevent other helicopters from landing.

**NOTES:**

1. Requirements for the structural design of helidecks are comprehensively set out in ISO 19901-3 Petroleum and natural gas industries – Specific requirements for offshore structures, Part 3: Topsides structure (published in December 2010). Useful guidance is also given in the Offshore Industry Advisory Committee (OIAC) publication 'Offshore Helideck Design Guidelines' published by the HSE.
2. Consideration should be given to the possibility of accommodating an unserviceable helicopter in a designated parking or run-off area (where provided) adjacent to the helideck to allow a relief helicopter to land. If this contingency is designed into the construction/operating philosophy of the installation, the

helicopter operator should be advised of any weight restrictions imposed on the relief helicopter by structural integrity considerations. Where a parking or run-off area is provided it is assumed that the structural considerations will at least meet the loads criteria applicable for helicopters at rest (see paragraph 5).

3. Alternative loading criteria equivalent to those recommended here and in paragraphs 4 and 5 may be used where aircraft-specific loads have been derived by the aircraft manufacturer from a suitable engineering assessment taking account of the full range of potential landing conditions, including failure of a single engine at a critical point, and the behaviour of the aircraft undercarriage and the response of the helideck structure. The aircraft manufacturer should provide information to interested parties, including the owner or operator of the installation, the helicopter operators and the HSE to justify any such alternative criteria. The aircraft manufacturer may wish to seek the opinion of the CAA on the basis of the criteria to be used. In consideration of alternative criteria, the CAA is content to assume that a single engine failure represents the worst case in terms of rate of descent on to the helideck amongst likely survivable emergencies.

## 4 Loads – Helicopters Landing

4.1 The helideck should be designed to withstand all the forces likely to act when a helicopter lands. The loads and load combinations to be considered should include:

- a) **Dynamic load due to impact landing.** This should cover both a heavy normal landing and an emergency landing. For the former, an impact load of  $1.5 \times \text{MTOM}$  of the helicopter should be used, distributed as described in paragraph 3.3. This should be treated as an imposed load, applied together with the combined effect of b) to f) in any position on the landing area so as to produce the most severe load on each structural element. For an emergency landing, an impact load of  $2.5 \times \text{MTOM}$  should be applied in any position on the landing area together with the combined effects of b) to f) inclusive. Normally, the emergency landing case will govern the design of the structure.
- b) **Sympathetic response of landing platform.** After considering the design of the helideck structure's supporting beams and columns and the characteristics of the designated helicopter, the dynamic load (see a) above) should be increased by a suitable structural response factor depending upon the natural frequency of the helideck structure. It is recommended that a structural response factor of 1.3 should be used unless further information allows a lower factor to be calculated. Information required to do this will include the natural periods of vibration of the helideck and the dynamic characteristics of the designated helicopter and its landing gear.
- c) **Overall superimposed load on the landing platform.** To allow for any appendages that may be present on the deck surface (e.g. helideck net, "H" and circle lighting etc.) in addition to wheel loads, an allowance of 0.5 kiloNewtons per square metre ( $\text{kN/m}^2$ ) should be added over the whole area of the helideck.
- d) **Lateral load on landing platform supports.** The landing platform and its supports should be designed to resist concentrated horizontal imposed loads equivalent to  $0.5 \times \text{MTOM}$  of the helicopter, distributed between the undercarriages in proportion to the applied vertical loading in the direction which will produce the most severe loading on the element being considered.
- e) **Dead load of structural members.** This is the normal gravity load on the element being considered.

- f) **Wind loading.** Wind loading should be allowed for in the design of the platform. The 100-year return period wind actions should be applied in the direction which, together with the imposed lateral loading, will produce the most severe loading condition on each structural element.
- g) **Punching shear.** A check should be made for the punching shear from a wheel of the landing gear with a contact area of  $65 \times 10^3 \text{ mm}^2$  acting in any probable location. Particular attention to detailing should be taken at the junction of the supports and the platform deck.

## 5 Loads – Helicopters at Rest

- 5.1 The helideck should be designed to withstand all the applied forces that could result from a helicopter at rest; the following loads should be taken into account:
- a) **Imposed load from helicopter at rest.** All areas of the helideck accessible to a helicopter, including any separate parking or run-off area, should be designed to resist an imposed load equal to the MTOM of the helicopter. This load should be distributed between all the landing gear. It should be applied in any position on the helideck so as to produce the most severe loading on each element considered.
  - b) **Overall superimposed load.** To allow for personnel, freight, refuelling equipment and other traffic, snow and ice, rotor downwash etc., an allowance of 2.0 kiloNewtons per square metre ( $\text{kN/m}^2$ ) should be added to the whole area of the helideck.
  - c) **Dead load and wind load.** The values for these loads are the same as given in paragraph 4.1 e) and f) and should be considered to act simultaneously in combination with a) and b). Consideration should also be given to the additional wind loading from any parked or secured helicopter.
  - d) **Acceleration forces and other dynamic amplification forces.** The effect of these forces, arising from the predicted motions of mobile installations and vessels, in the appropriate environmental conditions (corresponding to a 10-year return period), should be considered.

## 6 Size and Obstacle Protected Surfaces

**NOTE:** The location of a specific helideck is often a compromise given the competing requirements for space. Helidecks should be at or above the highest point of the main structure. This is a desirable feature but it should be appreciated that if this entails a landing area much in excess of 60 m above sea level, the regularity of helicopter operations may be adversely affected in low cloud base conditions.

- 6.1 For any particular type of single main rotor helicopter, the helideck should be sufficiently large to contain a circle of diameter D equal to the largest dimension of the helicopter when the rotors are turning. This D-circle should be totally unobstructed (see Table 1 for D values). Due to the actual shape of most offshore helidecks the D-circle will be 'hypothetical' but the helideck shape should be capable of accommodating such a circle within its physical boundaries.
- 6.2 From any point on the periphery of the above mentioned D-circle an obstacle-free approach and take-off sector should be provided which totally encompasses the landing area (and D-circle) and which extends over a sector of at least  $210^\circ$ . Within this sector obstacle accountability should be considered out to a distance from the periphery of the landing area that will allow for an unobstructed departure path appropriate to the helicopter the helideck is intended to serve. For helicopters

operated in Performance Class 1 or 2 the horizontal extent of this distance from the helideck will be based upon the one-engine inoperative capability of the helicopter type to be used. In consideration of the above, only the following items essential for safe helideck operations may exceed the height of the landing area, but should not do so by more than 25 centimetres for any helideck where the D-value is greater than 16.00 m or by more than 5 cm for any helideck where the D-value is 16.00 m or less:

- the guttering (associated with the requirements in paragraph 7.2);
- the lighting required by Chapter 4;
- the foam monitors (where provided); and
- those handrails and other items (e.g. EXIT sign) associated with the landing area which are incapable of complete retraction or lowering for helicopter operations.

6.3 Objects whose function requires that they be located on the surface of the helideck such as landing nets, tie-down points, and "circle" and "H" lighting systems (see Appendix C) should not exceed a height of 25 mm. Such objects should only be present above the surface of the touchdown area provided they do not cause a hazard to helicopter operations.

6.4 The bisector of the 210° Obstacle Free Sector (OFS) should normally pass through the centre of the D-circle. The sector may be 'swung' by up to 15° as illustrated in Figure 1. Acceptance of the 'swung' criteria will normally only be applicable to existing installations.

**NOTE:** If the 210° OFS is swung, then it would be normal practice to swing the 180° falling 5:1 gradient by a corresponding amount to indicate, and align with, the swung OFS.

6.5 The diagram at Figure 1 shows the extent of the two segments of the 150° Limited Obstacle Sector (LOS) and how these are measured from the centre of the (hypothetical) D-circle and from the perimeter of the landing area. This diagram assumes, since most helidecks are designed to the minimum requirement of accommodating a 1 D-circle, that the D-circle perimeter and landing area perimeter are coincidental. No objects above 25 cm (or 5 cm where the D-value of the helideck is 16.00 m or less) are permitted in the first (hatched area in Figure 1) segment of the LOS. The first segment extends out to 0.62D from the centre of the D-circle, or 0.12D from the landing area perimeter marking. The second segment of the LOS, in which no obstacles are permitted to penetrate, is a rising 1:2 slope originating at a height of 0.05D above the helideck surface and extending out to 0.83D from the centre of the D-circle (i.e. a further 0.21D from the edge of the first segment of the LOS).

**NOTE:** The exact point of origin of the LOS is assumed to be at the periphery of the D-circle.

6.6 Some helidecks are able to accommodate a landing area which covers a larger area than the declared D-value; a simple example being a rectangular deck with the minor dimension able to contain the D-circle. In such cases it is important to ensure that the origin of the LOS (and OFS) is at the perimeter of the landing area as marked by the perimeter line. Any landing area perimeter should guarantee the obstacle protection afforded by both segments of the LOS. The respective measurements of 0.12D from the landing area perimeter line plus a further 0.21D are to be applied. On these larger decks there is thus some flexibility in deciding the position of the perimeter line and landing area in order to meet the LOS requirements and when considering the position and height of fixed obstacles. Separating the origin of the LOS from the perimeter of the D-circle in Figure 1 and moving it to the right of the page will demonstrate how this might apply on a rectangular-shaped landing area.

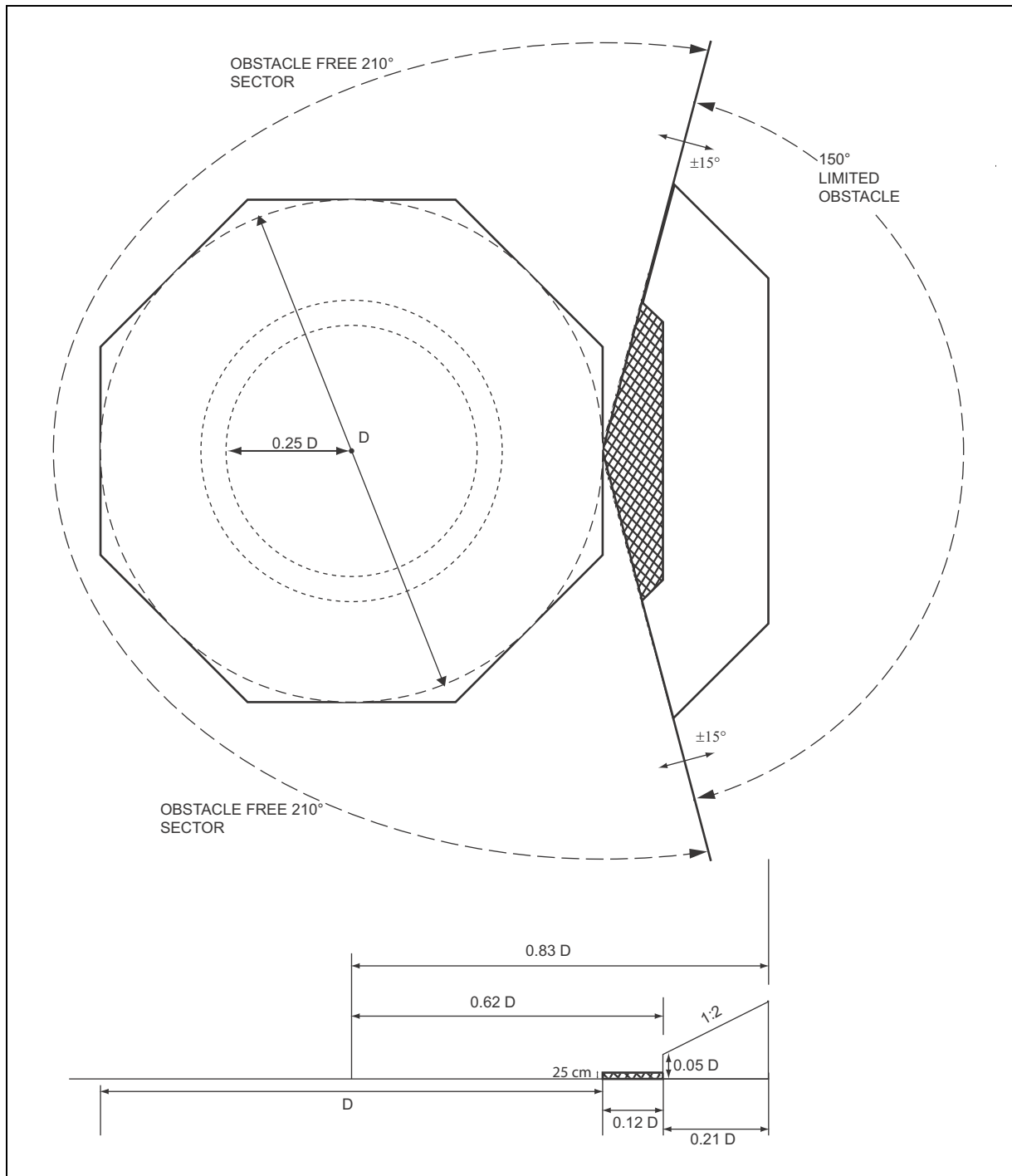

**Figure 1** Obstacle Limitation (Single Main Rotor and Side by Side Main Rotor Helicopters) showing position of Touchdown/Positioning Marking circle

**Note:** Where the D-value is 16.00 m or less, objects in the first segment of the LOS are restricted to 5 cm.

6.7 The extent of the LOS segments will, in all cases, be lines parallel to the landing area perimeter line and follow the boundaries of the landing area perimeter (see Figure 1). Only in cases where the perimeter of the landing area is circular will the extent of the LOS be in the form of arcs to the D-circle. However, taking the example of an octagonal landing area as drawn at Figure 1, it would be possible to replace the angled corners of the two LOS segments with arcs of  $0.12D$  and  $0.33D$  centred on the two adjacent corners of the landing area, thus cutting off the angled corners of the LOS

segments. If these arcs are applied they should not extend beyond the two corners of each LOS segment so that minimum clearances of 0.12D and 0.33D from the corners of the landing area are maintained. Similar geometric construction may be made to a square or rectangular landing area but care should be taken to ensure that the LOS protected surfaces minima can be satisfied from all points on the inboard perimeter of the landing area.

- 6.8 Whilst application of the criteria in paragraph 6.2 will ensure that no unacceptable obstructions exist above the helicopter landing area level over the whole 210° sector, it is necessary to consider the possibility of helicopter loss of height due to a power unit failure during the latter stages of the approach or early stages of take-off. Accordingly, a clear zone should be provided below landing area level on all fixed and mobile installations between the helideck and the sea. The falling 5:1 gradient should be at least 180° with an origin at the centre of the D-circle and ideally it should cover the whole of the 210° OFS. It should extend outwards for a distance that will allow for safe clearance from obstacles below the helideck in the event of an engine failure for the type of helicopter the helideck is intended to serve. (See also Glossary of Terms and Abbreviations.) For helicopters operated in Performance Class 1 or 2 the horizontal extent of this distance from the helideck will be based upon the one-engine inoperative capability of the helicopter type to be used (see Figure 2). All objects that are underneath anticipated final approach and take-off paths should be assessed.

- NOTES:**
1. For practical purposes the falling obstacle limitation surface can be assumed to be defined from points on the outboard edge of the helideck perimeter safety netting supports (not less than 1.5 metres from deck edge). Minor infringements of the surface by foam monitor platforms or access/escape routes may be accepted only if they are essential to the safe operation of the helideck but may also attract helicopter operational limitations.
  2. Research completed in 1999 (see Appendix B references) demonstrated that, following a single engine failure in a twin engine helicopter after take-off decision point, and assuming avoidance of the deck edge, the resulting trajectory will carry the helicopter clear of any obstruction in the range 2:1 to 3:1. It is therefore only necessary for operators to account for performance in relation to specified 5:1 falling gradient when infringements occur to a falling 3:1 rather than a 5:1 slope.

- 6.9 It is recognised that when support installations, such as 'flotels' and crane-barges, are operating close to other installations, it will not always be possible to meet the horizontal and vertical obstacle protected surface requirements. In these circumstances, installation operators should attempt to meet the above criteria as closely as possible when planning the siting of a combination of installations or an installation and a vessel, and should forward drawings of the proposed configuration to the agency responsible for the certification of the helideck as early as possible in the process for assessment and consultation on the operational aspects. Consultation with the helicopter operators in the early planning stages will help to optimise helicopter operations for support installation location.

- NOTE:** As a general rule, on helidecks where obstacle-protected surfaces are infringed by other installations or vessels positioned within a horizontal distance from the helideck which is based upon the airspace requirements needed to accommodate the one-engine inoperative capability of the helicopter type to be used, it may be necessary to impose helicopter operating restrictions on one or all of the helidecks affected. The Management and Control of Combined Operations is discussed in more detail in the OGUK Guidelines for the Management of Aviation Operations.



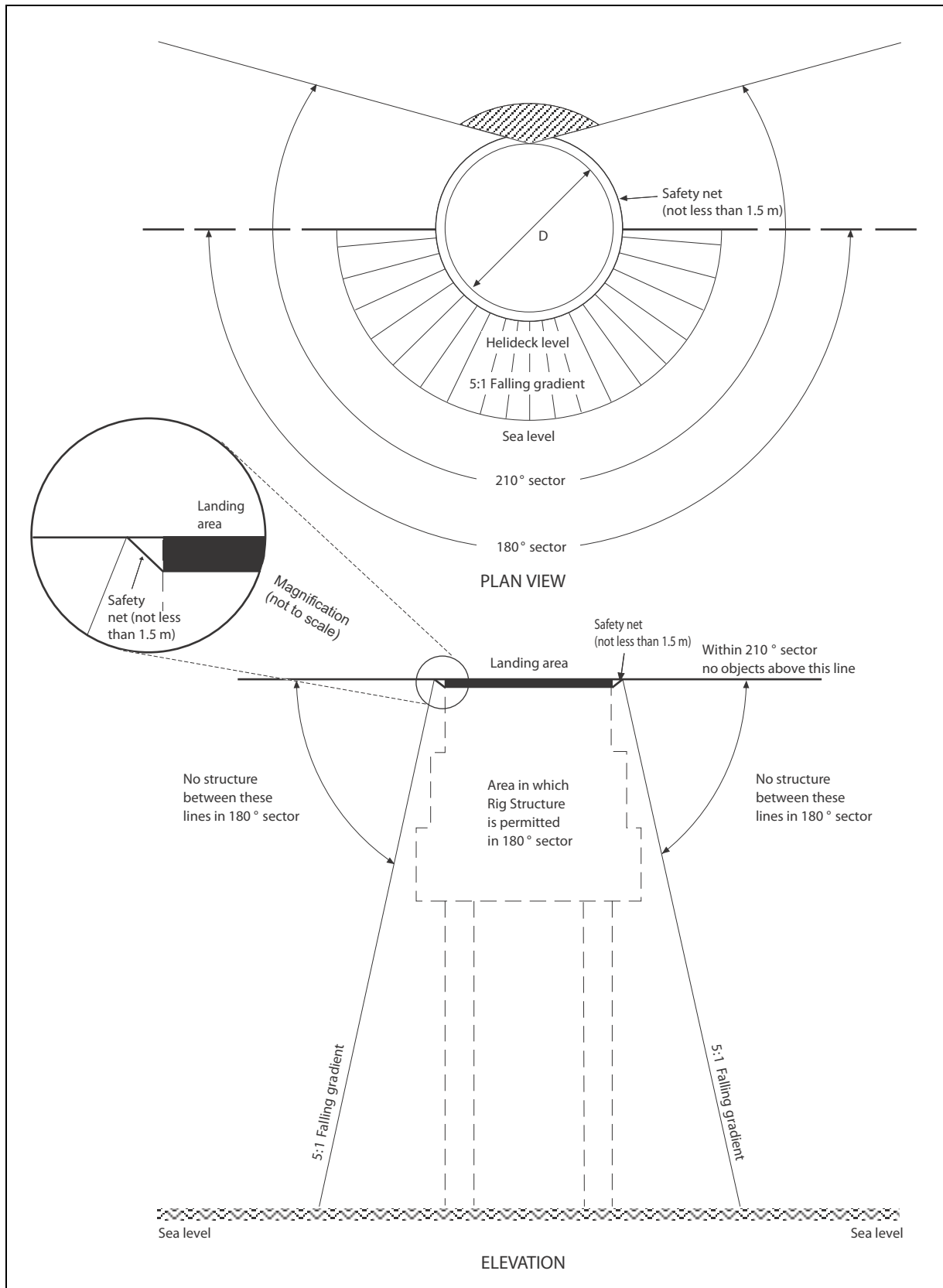

**Figure 2** Obstacle Free Areas – Below Landing Area Level (for all types of helicopters)

6.10 It is accepted that, at times, short-term infringement to obstacle-protected surfaces cannot be avoided when, for example, supply/support vessels work close to an installation. It may be impractical to assess such situations within the time available.

However, the helicopter operator may need to apply operational limitations in such circumstances. It is therefore important for helicopter crews to be kept informed of all temporary infringements.

## 7 Surface

**NOTE:** Where a helideck is constructed in the form of a grating, e.g. where a passive fire-retarding system is selected (see Chapter 5), the design of the helideck should ensure that ground effect is not reduced.

- 7.1 The landing area should have an overall coating of non-slip material and all markings on the surface of the landing area should be finished with the same non-slip materials. Whilst extruded section or grid construction aluminium (or other) decks may provide adequate resistance to sliding, they should be coated with a non-slip material unless adequate friction properties have been confirmed by measurement (see paragraph 7.5). It is important that adequate friction exists in all directions and in worst case conditions, i.e. when the deck is wet. Over-painting friction surfaces on such designs with other than non-slip material will likely compromise the surface friction. Suitable surface friction material is available commercially.

**NOTE:** Full-scale testing of a sample of aluminium helidecks has indicated that such decks are unlikely to meet the minimum friction requirement without a non-slip coating or some other verified means. This work is to be published in a CAA Paper for reference in a future edition of CAP 437.

- 7.2 Every landing area should be equipped with adequate surface drainage arrangements and a free-flowing collection system that will quickly and safely direct any rainwater and/or fuel spillage and/or fire fighting media away from the helideck surface to a safe place. Helidecks on fixed installations should be cambered (or laid to a fall) to approximately 1:100. Any distortion of the helideck surface on an installation due to, for example, loads from a helicopter at rest should not modify the landing area drainage system to the extent of allowing spilled fuel to remain on the deck. A system of guttering on a new-build or a slightly raised kerb should be provided around the perimeter to prevent spilled fuel from falling on to other parts of the installation and to conduct the spillage to an appropriate drainage system. The capacity of the drainage system should be sufficient to contain the maximum likely spillage of fuel on the helideck. The calculation of the amount of spillage to be contained should be based on an analysis of helicopter type, fuel capacity, typical fuel loads and uplifts. The design of the drainage system should preclude blockage by debris. The helideck area should be properly sealed so that spillage will only route into the drainage system.

- 7.3 Tautly-stretched rope netting should be provided to aid the landing of helicopters with wheeled undercarriages in adverse weather conditions. The intersections should be knotted or otherwise secured to prevent distortion of the mesh. It is preferable that the rope be constructed of sisal, with a maximum mesh size of 200 mm. The rope should be secured at intervals approximately 1.5 metres between the lashing points around the landing area perimeter and tensioned to at least 2225 N. Subject to acceptance by the agency responsible for the certification of the helideck, netting made of material other than sisal may be considered but netting should not be constructed of polypropylene-type material which is known to rapidly deteriorate and flake when exposed to weather. Tensioning to a specific value may be impractical offshore. As a rule of thumb, it should not be possible to raise any part of the net by more than approximately 250 mm above the helideck surface when applying a vigorous vertical pull by hand. The location of the net should ensure coverage of the

area of the TD/PM but should not cover the helideck identification marking or 't' value markings. Some nets may require modification to corners so as to keep the identification markings uncovered. In such circumstances the dimensions given in Table 2 may be modified.

**NOTE:** It should be borne in mind when selecting an appropriate helideck netting solution that the height of the netting (i.e. the thickness of the installed net including knots) should accord with the requirements specified in paragraph 6.3.

- 7.4 There are three standard sizes of netting as listed below in Table 2. The minimum size depends upon the type of helicopter for which the landing area is to be used as indicated in Table 1.

**Table 2** Helicopter Deck Netting

Small	9 metres by 9 metres
Medium	12 metres by 12 metres
Large	15 metres by 15 metres

**NOTE:** Some helideck nets may be circular rather than square. Netting should cover the whole of the TD/PM Circle and it may be necessary to utilise non-standard sizes of netting to achieve this.

- 7.5 For fixed Normally Attended Installations (NAIs), where no significant movement due to environmental conditions occurs, provided the helideck can be shown to achieve an average surface friction value of not less than 0.65 determined by a test method acceptable to the CAA, the helideck landing net may be removed. The installation operator should ensure thereafter that the helideck is kept free from oil, grease, ice, snow, excessive surface water or any other contaminant (particularly guano) that could degrade surface friction. Assurance should be provided to the helicopter operator that procedures are in place for elimination and removal of contaminants prior to helicopter movements. Following removal of the netting, the helideck should be re-tested at regular intervals. The criteria for initial removal and the frequency of subsequent testing should be approved by an ICP, subject to the guidance contained in CAA Paper 98002. Friction testing periodicity can be determined using a simple trend analysis as described in this paper. Table 3 indicates typical frequencies of inspection for given ranges of friction values.

**NOTE:** A review of helideck friction measurement techniques has concluded that the test method should involve a friction measuring device that:

- employs the braked wheel technique;
- is able to control the wetness of the deck during testing;
- includes electronic data collection, storage and processing; and
- allows the whole of the deck surface to be covered to a resolution of not less than 1 m<sup>2</sup>.

The minimum average surface friction value of 0.65 should be achieved across the area inside the TD/PM, outside the TD/PM and on the paint markings themselves. An example test protocol will be produced and published in a CAA Paper for reference in a future edition of CAP 437.

- 7.6 Consideration to remove landing nets on Normally Unattended Installations (NUIs) may only be given if procedures are in place which guarantee that the helideck will remain clear of contaminants such that there is no risk of helideck markings and visual cues being compromised or friction properties reduced.

- 7.7 Landing nets on mobile installations have generally, in the absence of any research, been regarded as essential. However, it may be possible to present a safety case to the agency responsible for the certification of the helideck for specific installations.

**Table 3** Friction Requirements for Landing Area Net Removal

Average surface friction value	Maximum period between tests
0.85 and above (Recognised Friction Surface) <sup>1</sup>	36 months
0.7 to 0.84	12 months
0.65 to 0.69	6 months
Less than 0.65 <sup>1</sup>	Net to be retained

1. Refer to CAA Paper 98002

- 7.8 Experience has shown that the removal of landing nets on some installations has resulted in undesirable side-effects. Although the purpose of the landing net is to help prevent the helicopter sliding on the helideck, it does also provide a degree of visual cueing to pilots in terms of rate of closure and lateral movement. Such visual cueing is essential for safe control of the helicopter and, on some installations, removal of the landing net could significantly degrade the cueing environment. Serious consideration should be given to this aspect before a landing net is removed. The helicopter operator should be consulted before existing landing nets are removed and installation operators should be prepared to re-fit landing nets if so advised by the helicopter operator in the case that visual cueing difficulties are experienced. For these reasons it is also recommended that the design of new installations should incorporate the provision of landing net fittings regardless of the type of friction surface to be provided.

## 8 Helicopter Tie-Down Points

- 8.1 Sufficient flush fitting (when not in use) tie-down points should be provided for securing the maximum sized helicopter for which the helideck is designed. They should be so located and be of such strength and construction to secure the helicopter when subjected to weather conditions pertinent to the installation design considerations. They should also take into account, where significant, the inertial forces resulting from the movement of floating units.

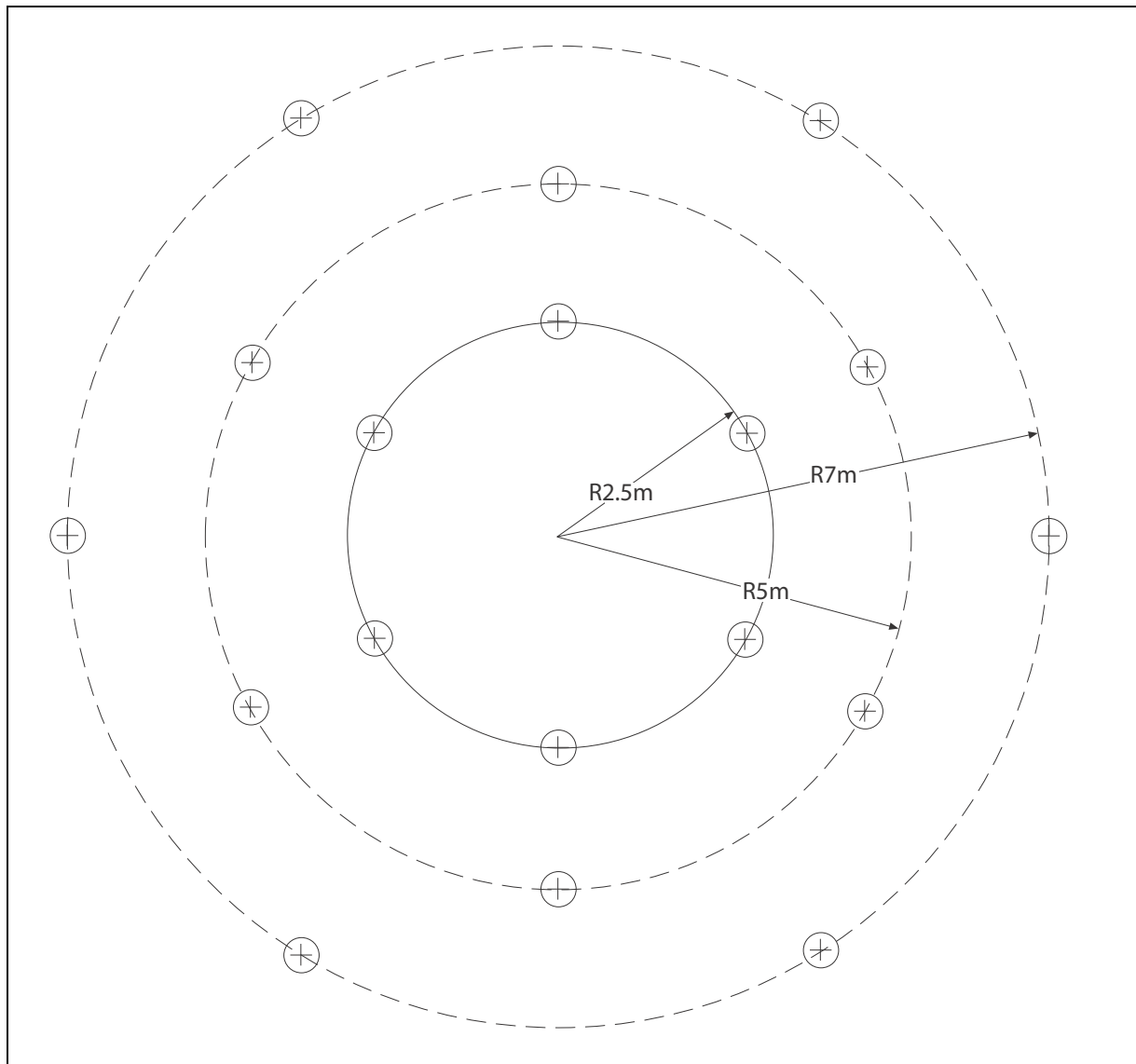

**Figure 3** Example of Suitable Tie-down Configuration

- NOTES:**
1. The tie-down configuration should be based on the centre of the TD/PM Circle.
  2. Additional tie-downs will be required in a parking area.
  3. The outer circle is not required for D-values of less than 22.2 m.

- 8.2 Tie-down points should be compatible with the dimensions of tie-down strop attachments. Tie-down points and strops should be of such strength and construction so as to secure the helicopter when subjected to weather conditions pertinent to the installation design considerations. The maximum bar diameter of the tie-down point should be 22 mm in order to match the strop hook dimension of the tie-down strops carried in most UK offshore helicopters. Advice on recommended safe working load requirements for strop/ring arrangements for specific helicopter types can be obtained from the helicopter operator.
- 8.3 An example of a suitable tie-down configuration is shown at Figure 3. The agency responsible for the certification of the helideck should be able to provide guidance on the configuration of the tie-down points for specific helicopter types.

## 9 Perimeter Safety Net

- 9.1 Safety nets for personnel protection should be installed around the landing area except where adequate structural protection against a fall exists. The netting used should be of a flexible nature, with the inboard edge fastened just below the edge of the helicopter landing deck. The net itself should extend at least 1.5 metres in the horizontal plane and be arranged so that the outboard edge does not exceed the level of the landing area and angled so that it has an upward and outward slope of approximately 10°.
- 9.2 A safety net designed to meet these criteria should 'contain' personnel falling into it and not act as a trampoline. Where lateral or longitudinal centre bars are provided to strengthen the net structure they should be arranged and constructed to avoid causing serious injury to persons falling on to them. The ideal design should produce a 'hammock' effect which should securely contain a body falling, rolling or jumping into it, without serious injury. When considering the securing of the net to the structure and the materials used, care should be taken that each segment will be fit for purpose. Polypropylene deteriorates over time; various wire meshes have been shown to be suitable if properly installed.

- NOTES:**
1. It is not within the scope or purpose of CAP 437 to provide detailed advice for the design, fabrication and testing of helideck perimeter nets. These specific issues are addressed in the OGUK 'Guidelines for the Management of Aviation Operations'.
  2. Perimeter nets may incorporate a hinge arrangement to facilitate the removal of sacrificial panels for testing.
  3. Perimeter nets that extend up to 2.0 m in the horizontal plane, measured from the edge of the landing area, are unlikely to attract operational limitations.

## 10 Access Points

- 10.1 For reasons of safety it is necessary to ensure that embarking and disembarking passengers are not required to pass around the helicopter tail rotor, or around the nose of helicopters having a low profile main rotor, when a 'rotors-running turn-round' is conducted (in accordance with normal offshore operating procedures). Many helicopters have passenger access on one side only and helicopter landing orientation in relation to landing area access points is therefore very important.
- 10.2 There should be a minimum of two access/egress routes to the helideck. The arrangements should be optimised to ensure that, in the event of an accident or incident on the helideck, personnel will be able to escape upwind of the landing area. Adequacy of the emergency escape arrangements from the helideck should be included in any evacuation, escape and rescue analysis for the installation, and may require a third escape route to be provided.
- 10.3 The need to preserve, in so far as possible, an unobstructed falling 5:1 gradient (see paragraphs 6.8 and 6.9) and the provision of up to three helideck access/escape routes, with associated platforms, may present a conflict of requirements. A compromise may therefore be required between the size of the platform commensurate with its effectiveness and the need to retain the protection of an unobstructed falling 5:1 gradient. In practice, the 5:1 gradient is taken from the outboard edge of the helideck perimeter safety net supports. Emergency access points which extend outboard from the perimeter safety net constitute a compromise in relation to an unobstructed falling 5:1 gradient which may lead, in some instances, to the imposition of helicopter operating limitations. It is therefore important to construct access point platforms in such a manner as to infringe the falling 5:1

gradient by the smallest possible amount but preferably not at all. Suitable positioning of two major access points clear of the requirements of the protection of the falling 5:1 gradient should be possible. However, the third access referred to at paragraph 10.2 will probably lie within the falling 5:1 sector and where this is the case it should be constructed within the dimensions of the helideck perimeter safety net supports (i.e. contained within a horizontal distance of 1.5 - 2.0 m measured from the edge of the landing area).

- 10.4 Where foam monitors are co-located with access points care should be taken to ensure that no monitor is so close to an access point as to cause injury to escaping personnel by operation of the monitor in an emergency situation.
- 10.5 Where handrails associated with helideck access/escape points exceed the height limitations given at paragraph 6.2 they should be retractable, collapsible or removable. When retracted, collapsed or removed the rails should not impede access/egress. Handrails which are retractable, collapsible and removable should be painted in a contrasting colour scheme. Procedures should be in place to retract, collapse or remove them prior to helicopter arrival. Once the helicopter has landed, and the crew have indicated that passenger movement may commence (see Note below), the handrails may be raised and locked in position. The handrails should be retracted, collapsed or removed again prior to the helicopter taking off.

**NOTE:** The helicopter crew will switch off the anti-collision lights to indicate that the movement of passengers and/or freight may take place (under the control of the HLO). Installation/vessel safety notices placed on approach to the helideck access should advise personnel not to approach the helicopter when the anti-collision lights are on.

## 11 Winching (Hoist) Operations

- 11.1 It should be noted that for any installation or vessel, attended or unattended, fixed or mobile for which helicopters are a normal mode of transport for personnel, a helicopter landing area should be provided. Winching should not be adopted as a normal method of transfer. However, if winching operations are required, they should be conducted in accordance with procedures agreed between the helicopter operator and the CAA and contained within the helicopter operator's Operations Manual. Requirements for winching operations should be discussed with the specific helicopter operator well in advance. Winching area design arrangements are described in more detail in Chapter 10.

## 12 Normally Unattended Installations (NUIs)

- 12.1 The CAA provides guidance for helicopter operators on the routeing of helicopters intending to land on NUIs. The CAA will also provide such guidance and advice to helicopter operators and installation operators in consideration of specific installation safety cases and risk analyses which address routeing philosophy.
- 12.2 Guano and associated bird debris is a major problem for NUIs. Associated problems concern the health hazard on board; degradation of visual aids (markings and lighting) and friction surfaces; and the potential for Foreign Object Debris/Damage (FOD). Helicopter operators should continuously monitor the condition of NUI helidecks and advise the owner/operator before marking and lighting degradation becomes a safety concern. Experience has shown that, unless adequate cleaning operations are undertaken or effective preventative measures are in place, essential visual aids will

quickly become obliterated. NUIs should be monitored continuously for signs of degradation of visual cues and flights should not be undertaken to helidecks where essential visual cues for landing are insufficient.

- 12.3 Guano is an extremely effective destroyer of friction surfaces whenever it is allowed to remain. Because of the difficulty of ensuring that a friction surface is kept clear of contaminants (see paragraphs 7.5 and 7.6), permanent removal of the landing net on NUIs is not normally a viable option unless effective preventative measures are in place.



# Chapter 4 Visual Aids

## 1 General

- 1.1 The name of the installation should be clearly displayed in such positions on the installation so that it can be readily identified from the air and sea from all normal angles and directions of approach. For identification from the air the helideck name and the side identification panels are used. It is not necessary, nor is it a legal requirement, to complicate recognition processes by inclusion of 'block numbers', company logos, or other designators. In fact, complication of identifiers can be confusing and will unnecessarily, and undesirably, extend the mental process of recognition at the critical time when the pilots' concentration is being fully exercised by the demands of the landing manoeuvre. The names on both identification markings should be identical, simple and unique and facilitate unambiguous communication via radio. The approved radio callsign of the installation should be the same name as the helideck and side panel identifier. Where the inclusion of 'block numbers' on side identification panels is deemed to be essential (i.e. for purposes other than recognition), the name of the installation should also be included; e.g. 'NAME. BLOCK NO.' The installation identification panels should be highly visible in all light conditions. They should be suitably illuminated at night and in conditions of poor visibility. In order to minimise the possibility of 'wrong rig landings' use of new technology is encouraged so that identification can be confirmed in the early stages of the approach by day and night. Modern technology is capable of meeting this requirement in most ambient lighting conditions. Use of high-intensity Light Emitting Diode (LED) cluster or fibre-optic systems in other applications have been shown to be effective even in severely reduced visibility. Additionally, it is recognised that alternative technologies have been developed consisting of highly visible reflective side signage that has been successfully installed on some installations with the co-operation of the helicopter operator. (HSE Operations Notice 39, re-issued in June 2008, provides 'Guidance on Identification of Offshore Installations'.)
- 1.2 Helideck markings (specifically the installation identification marking) and side identification panels are used by pilots to obtain a final pre-landing confirmation that the correct helideck is being approached. It is therefore **VITAL** that the helideck markings and side identification panels are maintained in the best possible condition, regularly re-painted and kept free of all visibility-reducing contaminants. Helideck owners/operators should ensure that specific inspection and re-painting maintenance procedures and schedules for helideck markings and side identification panels take account of the importance of their purpose. Side identification panels should be kept free of any obscuring paraphernalia (draped hoses etc.) and be as high as possible on the structure.
- 1.3 The installation identification (see paragraphs 1.1 and 1.2) should be marked on the helideck surface between the origin of the OFS and the TD/PM Circle in symbols not less than 1.2 metres high and in a colour (normally white) which contrasts with the helideck surface. The name should not be obscured by the deck net (where fitted).
- 1.4 Helideck perimeter line marking and lighting serves to identify the limits of the Landing Area (see Glossary) for day and night operations respectively.
- 1.5 A wind direction indicator (windsock) should be provided and located so as to indicate the free stream wind conditions at the installation/vessel location. It is often inappropriate to locate the primary windsock as close to the helideck as possible

where it may compromise obstacle protected surfaces, create its own dominant obstacle or be subjected to the effects of turbulence from structures resulting in an unclear wind indication. The windsock should be illuminated for night operations. Some installations may benefit from a second windsock to indicate a specific difference between the local wind over the helideck and the free stream wind.

- 1.6 For character marking dimensions, where character bar width is not specified, use 15% of character height with 10% of character height between characters (extreme right-hand edge of one character to extreme left-hand edge of next character) and approximately 50% of character height between words.

## 2 Helideck Landing Area Markings

- 2.1 The colour of the helideck should be dark green. The perimeter of the landing area should be clearly marked with a white painted line 30 cm wide (see Figure 1). Non-slip materials should be used (see Chapter 3, paragraph 7.1).

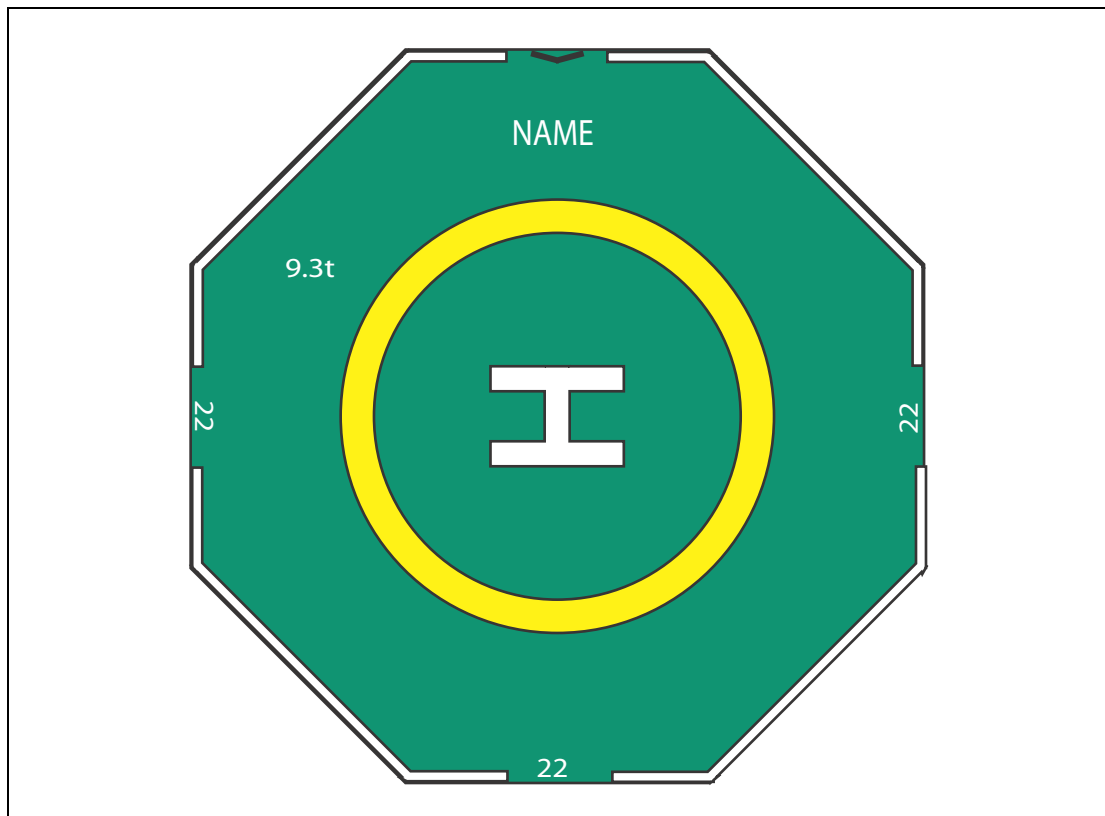

**Figure 1** Markings (Single Main Rotor Helicopters)

- 2.1.1 Aluminium helidecks are in use throughout the offshore industry. Some of these are a natural light grey colour and may present painting difficulties. The natural light grey colour of aluminium may be acceptable in specific helideck applications where these are agreed with the agency responsible for the certification of the helideck. This should be discussed in the early design phase. In such cases the conspicuity of the helideck markings may need to be enhanced by, for example, overlaying white markings on a painted black background. Additionally, conspicuity of the yellow TD/PM Circle may be enhanced by outlining the deck marking with a thin black line (typically 10 cm).

- 2.2 The origin of the 210° OFS for approach and take-off as specified in Chapter 3 should be marked on the helideck by a black chevron, each leg being 79 cm long and 10 cm wide forming the angle in the manner shown in Figure 2. On minimum sized helidecks where there is no room to place the chevron where indicated, the chevron marking, but not the point of origin, may be displaced towards the D-circle centre. Where the OFS is swung in accordance with the provision of Chapter 3 paragraph 6.4 this should be reflected in the alignment of the chevron. The purpose of the chevron is to provide visual guidance to the HLO so that he can ensure that the 210° OFS is clear of obstructions before giving a helicopter clearance to land. The black chevron may be painted on top of the (continuous) white perimeter line to achieve maximum clarity for the helideck crew.

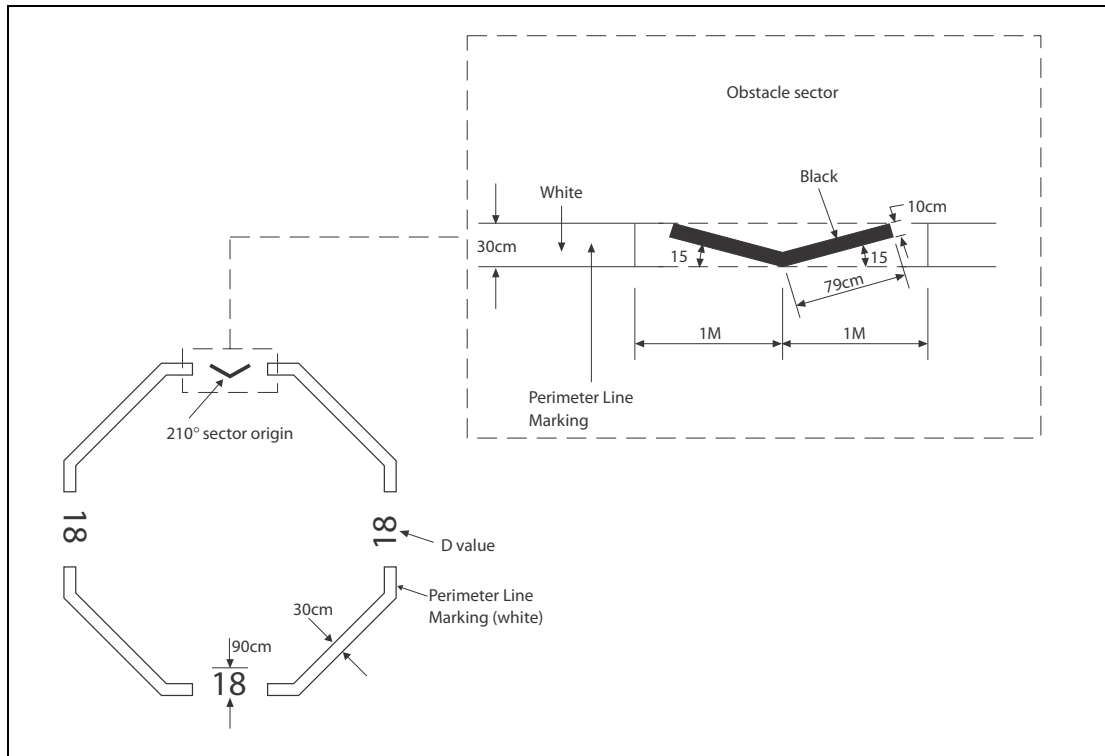
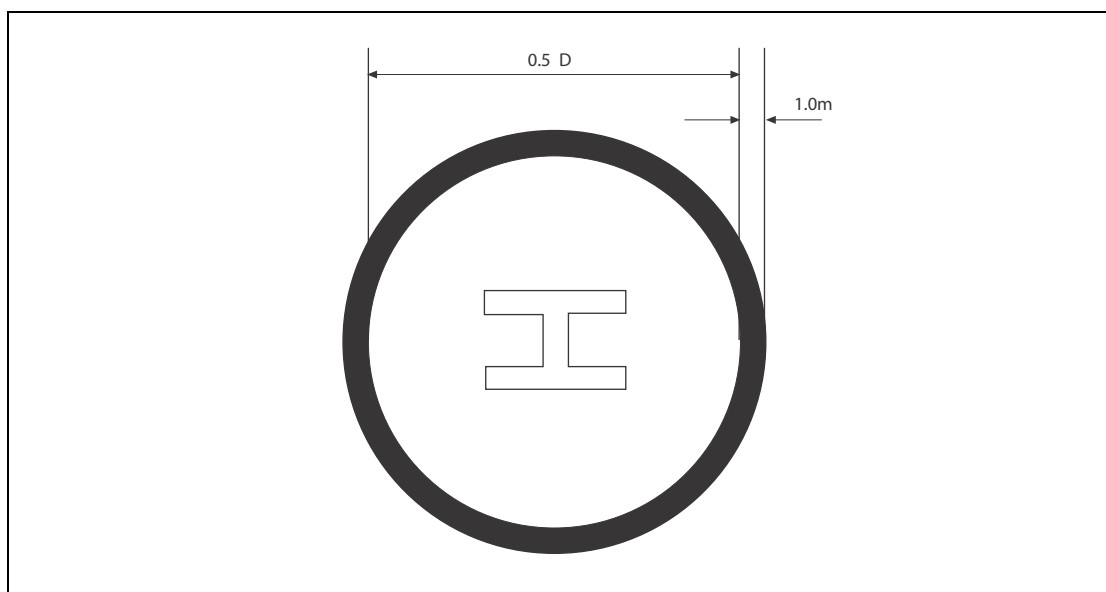

**Figure 2** Helideck D-value and Obstacle-free Marking

- 2.3 The actual D-value of the helideck (see Chapter 3, paragraph 6.1) should be painted on the helideck adjacent to, and where practical inboard of, the chevron in alphanumeric symbols 10 cm high. Where, for an existing installation, a helideck has been accepted which does not meet the normal minimum OFS requirements of 210°, the black chevron should represent the angle which has been accepted and this value should be marked inboard of the chevron in a similar manner to the certificated D-value. It is expected that new-builds will always comply in full with the requirement to provide a minimum 210° OFS.
- 2.4 The helideck D-value should also be marked around the perimeter of the helideck in characters no less than 90 cm high, in the manner shown in Figures 1 and 2 in a colour contrasting (preferably white: avoid black or grey for night use) with the helideck surface. The D-value should be expressed to the nearest whole number with 0.5 rounded down, e.g. 18.5 marked as 18 (see Chapter 3, Table 1).

**NOTE:** Helidecks designed specifically for AS332L2 and EC 225 helicopters, each having a D-value of 19.5 m, should be rounded up to 20 in order to differentiate between helidecks designed specifically for L1 models. For helidecks where the actual D-value is less than 15.00 m, the height of the numbers may be reduced from 90 cm to no less than 60 cm.

- 2.5 A maximum allowable mass marking should be marked on the helideck in a position which is readable from the preferred final approach direction, i.e. towards the OFS origin. The marking should consist of a two- or three-digit number expressed to one decimal place rounded to the nearest 100 kg and followed by the letter 't' to indicate the allowable helicopter mass in tonnes (1000 kg). The height of the figures should be 90 cm with a line width of approximately 12 cm and be in a colour which contrasts with the helideck surface (preferably white: avoid black or grey). Where possible the mass marking should be well separated from the installation identification marking (see paragraph 1.3) in order to avoid possible confusion on recognition. Refer also to Figure 1 and Chapter 3, Table 1.
- 2.6 A Touchdown/Positioning Marking (TD/PM) should be provided (see Figures 1 and 3). The marking should be a yellow circle with an inner diameter of 0.5 of the certificated D-value of the helideck and a line width of 1 metre. The centre of the marking should be concentric with the centre of the D-circle.



**Figure 3** Touchdown/Positioning Marking Circle (TD/PM Circle to be painted yellow)

**NOTE:** On a helideck the centre of the TD/PM Circle will normally be located at the centre of the landing area, except that the marking may be offset away from the origin of the OFS by no more than 0.1D where an aeronautical study indicates such offsetting to be beneficial, provided that the offset marking does not adversely affect the safety of flight operations or ground handling issues.

- 2.7 A white heliport identification marking 'H' marking should be marked co-located with the TD/PM with the cross bar of the 'H' lying along the bisector of the OFS. Its dimensions are as shown in Figure 4.

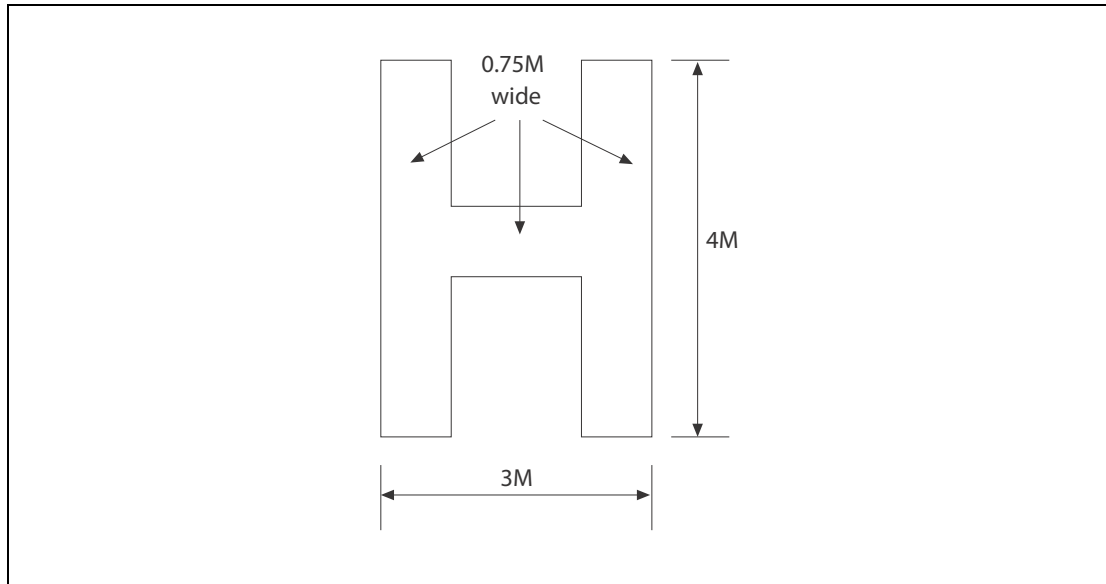

**Figure 4** Dimensions of heliport identification marking 'H' ('H' to be painted white)

- 2.8 Where the OFS has been swung in accordance with Chapter 3 paragraph 6.4 the positioning of the TD/PM and 'H' should comply with the normal unswung criteria. However, the 'H' should be orientated so that the bar is parallel to the bisector of the swung sector.
- 2.9 Prohibited landing heading sectors should be marked where it is necessary to protect the helicopter from landing or manoeuvring in close proximity to limiting obstructions which, for example, infringe the 150° LOS protected surfaces. When required, prohibited sectors are to be shown by red hatching of the TD/PM, with white and red hatching extending from the red hatching out to the edge of the landing area as shown in Figures 5 and 6.

**NOTE:** When positioning over the TD/PM helicopters should be manoeuvred so as to keep the aircraft **nose** clear of the hatched prohibited sector(s) at all times.

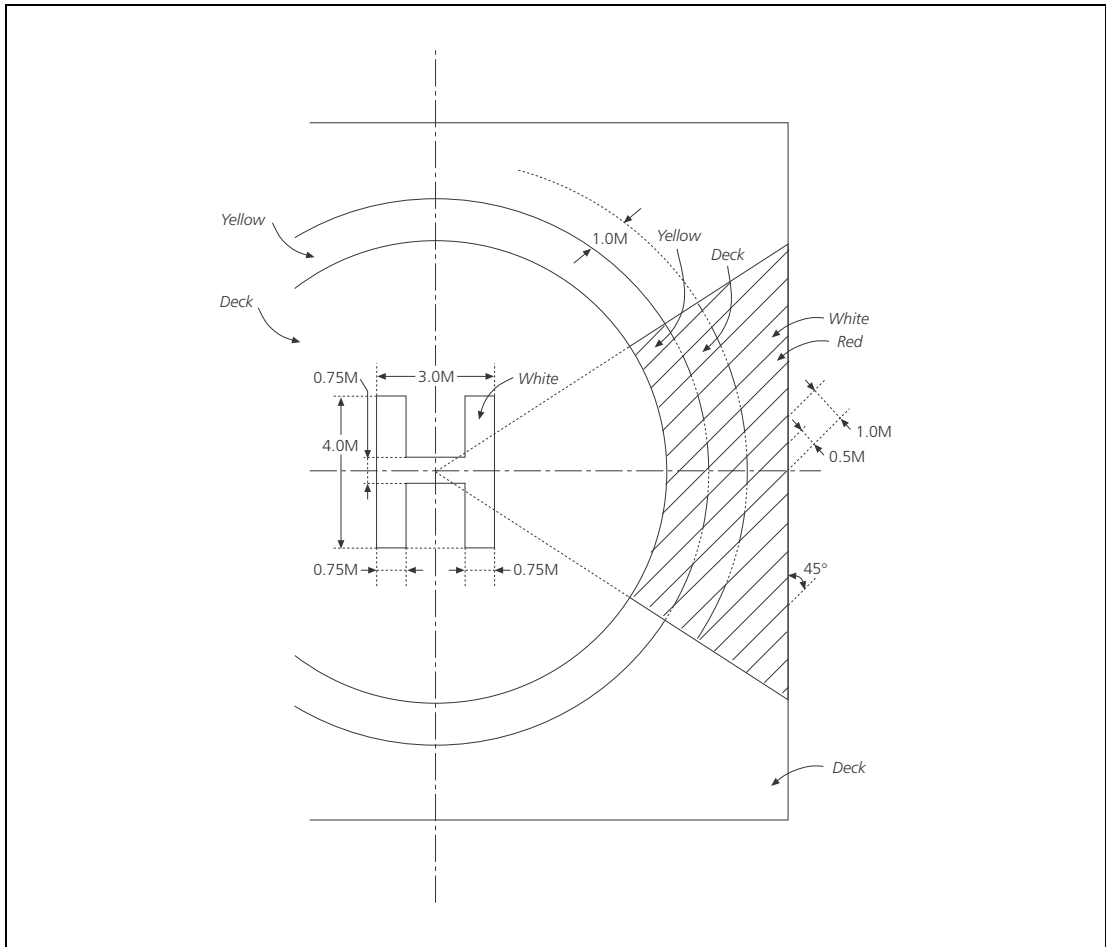

**Figure 5** Specification for the Layout of Prohibited Landing Heading Segments on Helidecks



**Figure 6** Example of Prohibited Landing Heading Marking

**NOTE:** The position of the 'H' and the orientation of the prohibited landing heading segment will depend on the obstacle.

- 2.10 For certain operational or technical reasons an installation may have to prohibit helicopter operations. In such circumstances, where the helideck cannot be used, the 'closed' state of the helideck should be indicated by use of the signal shown in Figure 7. This signal is the standard 'landing prohibited' signal given in the Rules of the Air and Air Traffic Control Regulations, except that it has been altered in size to just cover the letter 'H' inside the TD/PM.

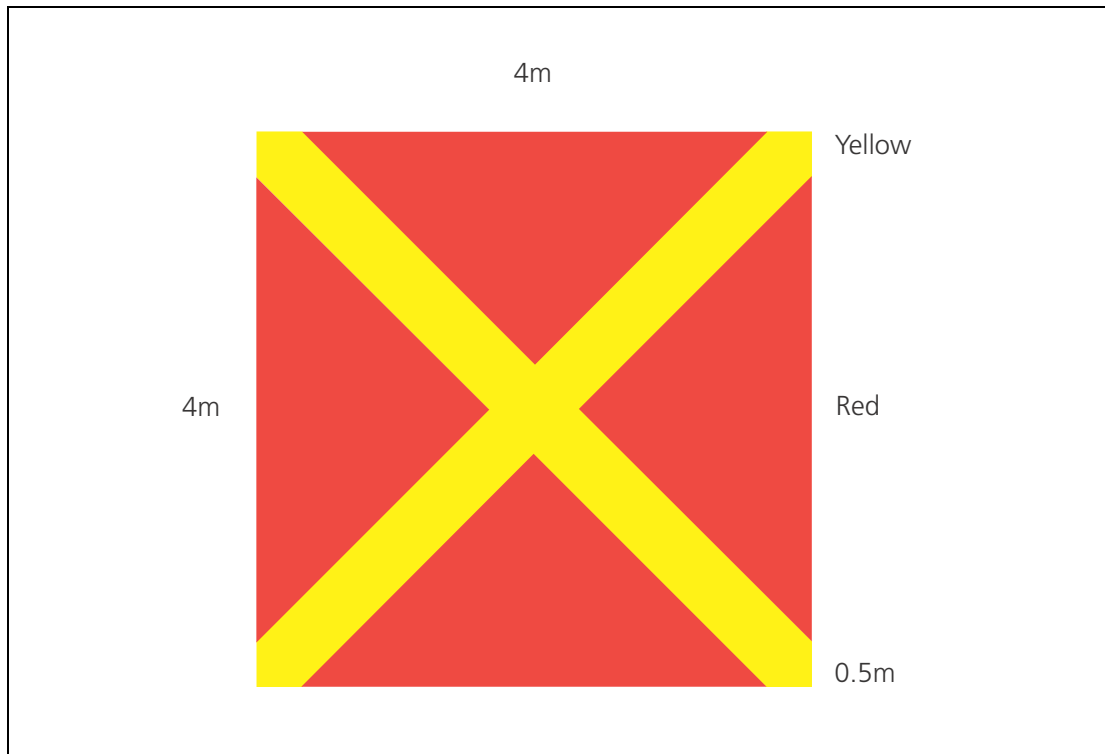

**Figure 7** Landing on Installation/Vessel Prohibited

**NOTE:** Signal covers 'H' inside TD/PM.

- 2.11 Colours should conform with the following BS 381C (1996) standard or the equivalent BS 4800 colour. White should conform to the RAL charts.
- a) RED
    - BS 381C: 537 (Signal Red)
    - BS 4800: 04.E.53 (Poppy)
  - b) YELLOW
    - BS 381C: 309 (Canary Yellow)
    - BS 4800: 10.E.53 (Sunflower Yellow)
  - c) DARK GREEN
    - BS 381C: 267 (Deep Chrome Green)
    - BS 4800: 14.C.39 (Holly Green)
  - d) WHITE
    - RAL 9010 (Pure White)
    - RAL 9003 (Signal White)

### 3 Lighting

- NOTES:**
1. The paragraphs below should be read in conjunction with Appendix C which contains the specification for the full helideck lighting scheme comprising perimeter lights, lit TD/PM Circle and lit heliport identification "H" marking. The specification for each element is fully described in Appendix C with the overall operational requirement detailed in paragraph 1 of the Appendix. The helideck lighting scheme is intended to provide effective visual cues for a pilot throughout the approach and landing manoeuvre at night. Starting with the initial acquisition of the helideck, the lighting needs to enable a pilot to easily locate the position of the helideck on the installation at long range on an often well lit offshore structure. The lighting should then guide the helicopter to a point above the landing area and then provide visual cues to assist with the touchdown.
  2. The specification has an in-built assumption that the performance of the helideck lighting system will not be diminished by any other lighting due to the relative intensity, configuration or colour of other lighting sources on the installation or vessel. Where other non-aeronautical ground lights have the potential to cause confusion or to diminish or prevent the clear interpretation of helideck lighting systems, it will be necessary for an installation or vessel operator to extinguish, screen or otherwise modify these lights to ensure that the effectiveness of the helideck lighting system is not compromised. This will include, but may not be limited to, an assessment of the effect of general installation lighting on the performance of the helideck lighting scheme. The CAA recommends that installation and vessel operators give serious consideration to shielding high intensity light sources (e.g. by fitting screens or louvers) from helicopters approaching and landing, and maintaining a good colour contrast between the helideck lighting and surrounding installation lighting. Particular attention should be paid to the areas of the installation adjacent to the helideck.
  3. The specification contained in Appendix C includes a facility to increase the intensity of some elements of the helideck lighting to compensate for installations or vessels with high levels of background lighting. The setting of the intensity of the helideck lighting should be carried out in conjunction with the helicopter operator as a once-off exercise following installation of the lighting, and subsequently if required following changes to the lighting environment at the installation or vessel. The intensity of the helideck lighting should not be routinely changed, and in any event should not be altered without the involvement and agreement of the helicopter operator.

- 3.1 The periphery of the landing area should be delineated by omni-directional green perimeter lights visible from on or above the landing area; however, the pattern formed by the lights should not be visible to the pilot from below the elevation of the landing area. Perimeter lights should be mounted above the level of the helideck but should not exceed the height limitations specified in Appendix C, paragraph 3.2. The lights should be equally spaced at intervals of not more than three metres around the perimeter of the landing area, coincident with the white line delineating the perimeter (see paragraph 2.1 above). In the case of square or rectangular decks there should be a minimum of four lights along each side including a light at each corner of the landing area. Recessed helideck perimeter lights may be used at the inboard (150° LOS origin) edge of the landing area where an operational need exists to move large items of equipment to and from the landing area, e.g. where a run-off area is provided there may be a need to move the helicopter itself to and from the landing area onto the adjacent run-off (parking) area. Care should be taken to select recessed helideck perimeter lights that will meet the iso-candela requirements stated in Appendix C, Table 2.



- 3.2 Where the declared D-value of the helideck is less than the physical helideck area, the perimeter lights should be coincidental with the white perimeter marking and black chevron and delineate the limit of the useable landing area so that, in unusual circumstances where a helicopter touches down inboard of the TD/PM Circle, it can land safely by reference to the perimeter lights on the 150° LOS 'inboard' side of the helideck without risk of the main rotor striking obstructions in this sector. By applying the LOS clearances (given in Chapter 3, paragraphs 6.5 to 6.7) from the perimeter marking and coincident lighting, adequate main rotor to obstruction separation should be achieved for the worst-case helicopter intended to operate to the helideck.
- 3.3 In order to aid the visual task of final approach and hover and landing it is important that adequate visual cues be provided. For use at night, this has previously been achieved using floodlighting; however, these systems can adversely affect the visual cueing environment by reducing the conspicuity of helideck perimeter lights during the approach, and by causing glare and loss of pilots' night vision during the hover and landing. Furthermore, floodlighting systems often fail to provide adequate illumination of the centre of the landing area leading to the so-called 'black-hole effect'.
- 3.4 A new lighting scheme comprising a lit TD/PM Circle and a lit heliport identification 'H' marking has therefore been developed. This scheme, described in detail in paragraphs 4 and 5 of Appendix C, has been clearly demonstrated to provide the visual cues required by the pilot earlier on in the approach, and much more effectively than floodlighting and without the disadvantages associated with floodlights such as glare. The CAA has therefore replaced the traditional floodlighting systems with the new offshore helideck lighting scheme meeting the specification given in Appendix C.

- NOTES:**
1. As a result of the G-REDU accident in February 2009, the Air Accidents Investigation Branch (AAIB) has published Air Accident Report 1/2011 which addresses a number of safety recommendations including Safety Recommendation 2011-053 recommending the amendment of CAP 437 to encourage operators of vessels and offshore installations equipped with helidecks to adopt the new lighting standard presented as a final specification in Appendix C.
  2. The new lighting scheme has been developed to be compatible with helicopters having wheeled undercarriages, this being the prevailing configuration on the UKCS during the development of the specification and at the time of publication. Although the design specifications detailed in Appendix C will ensure the segments and subsections containing lighting elements are compliant with the ICAO maximum obstacle height of 2.5 cm and likely to be able to withstand the point loading presented by (typically) lighter skidded aircraft, compatibility should be considered before operating skidded helicopters to helidecks fitted with the new lighting. Due to the potential for raised fittings to induce dynamic rollover of helicopters equipped with skids, it is important that, where the new lighting scheme is installed on helidecks used by skid-fitted helicopters, the height of the system (including any mounting arrangements) should be kept as low as possible.

3.5 Although no longer recommended for the provision of primary visual cueing, the CAA has no objection to floodlighting systems conforming to the guidance contained in Appendix G being retained for the purpose of providing a source of illumination for on-deck operations such as refuelling and passenger handling and, where required, for lighting the installation name on the helideck surface or as a back-up to the new lighting (see Note 2 below). Unless otherwise instructed by the aircrew the floodlights should be switched off during the acquisition, approach to hover, landing and take-off phases. In addition, particular care should be taken to maintain correct alignment to ensure that floodlights do not cause dazzle or glare to pilots while either in-flight or landed on the helideck. All floodlights should be capable of being switched on and off at the pilot's request. The floodlighting controls should be accessible to, and controlled by, the HLO or Radio Operator.

- NOTES:**
1. For some decks, especially NUIs, it may be beneficial to improve depth perception by redeploying floodlighting to illuminate the main structure or 'legs' of the platform.
  2. Floodlighting may be retained as a temporary source of alternative helideck lighting, e.g. in the event of guano rendering the new lighting ineffective on some NUIs. It is the CAA's view that the guano problem should be addressed, but it may nevertheless be desirable to retain Appendix G compliant floodlighting as a temporary back-up on some installations.

3.6 A visual warning system should be installed if a condition can exist on an installation which may be hazardous for the helicopter or its occupants. The system (Status Lights) should be a flashing red light (or lights), visible to the pilot from any direction of approach and on any landing heading. The aeronautical meaning of a flashing red light is either "do not land, aerodrome not available for landing" or "move clear of landing area". The system should be automatically initiated at the appropriate hazard level (e.g. impending gas release) as well as being capable of manual activation by the HLO. It should be visible at a range in excess of the distance at which the helicopter may be endangered or may be commencing a visual approach. CAA Paper 2008/01 provides a specification for a status light system which is summarised below:

- Where required, the helideck status signalling system should be installed either on or adjacent to the helideck. Additional lights may be installed in other locations on the platform where this is necessary to meet the requirement that the signal be visible from all approach directions, i.e. 360° in azimuth.
- The effective intensity should be a minimum of 700 cd between 2° and 10° above the horizontal and at least 176 cd at all other angles of elevation.
- The system should be provided with a facility to enable the output of the lights (if and when activated) to be dimmed to an intensity not exceeding 60 cd while the helicopter is landed on the helideck.
- The signal should be visible from all possible approach directions and while the helicopter is landed on the helideck, regardless of heading, with a vertical beam spread as shown in the second bullet point above.
- The colour of the status light(s) should be red as defined in ICAO Annex 14 Volume 1 Appendix 1, Colours for aeronautical ground lights.
- The light system as seen by the pilot at any point during the approach should flash at a rate of 120 flashes per minute. Where two or more lights are needed to meet this requirement, they should be synchronised to ensure an equal time gap (to within 10%) between flashes. While landed on the helideck, a flash rate of 60 flashes per minute is acceptable. The maximum duty cycle should be no greater than 50%.

- The light system should be integrated with platform safety systems such that it is activated automatically in the event of a process upset.
  - Facilities should be provided for the HLO to manually switch on the system and/or override automatic activation of the system.
  - The light system should have a response time to the full intensity specified not exceeding three seconds at all times.
  - Facilities should be provided for resetting the system which, in the case of NUIs, do not require a helicopter to land on the helideck.
  - The system should be designed so that no single failure will prevent the system operating effectively. In the event that more than one light unit is used to meet the flash rate requirement, a reduced flash frequency of at least 60 flashes per minute is considered acceptable in the failed condition for a limited period.
  - The system and its constituent components should comply with all regulations relevant to the installation.
  - Where the system and its constituent components are mounted in the 210° OFS or in the first segment of the LOS, the height of the installed system should not exceed 25 cm above deck level (or exceed 5 cm for any helideck where the D-value is 16.00 m or less).
  - Where supplementary 'repeater' lights are employed for the purposes of achieving the 'on deck' 360° coverage in azimuth, these should have a minimum intensity of 16 cd and a maximum intensity of 60 cd for all angles of azimuth and elevation.
- 3.7 Manufacturers are reminded that the minimum intensity specification stated above is considered acceptable to meet the **current** operational requirements, which specify a minimum meteorological visibility of 1400 m (0.75 NM). Development of offshore approach aids which permit lower minima (e.g. differential GPS) will require a higher intensity. Revised intensities are specified for the lowest anticipated meteorological visibility of 900 m (0.5 NM) in CAA Paper 2008/01, Appendix A.
- 3.8 Installation/vessel emergency power supply design should include the landing area lighting. Any failures or outages should be reported immediately to the helicopter operator. The lighting should be fed from an Uninterrupted Power Supply (UPS) system.

## 4 Obstacles – Marking and Lighting

- 4.1 Fixed obstacles which present a hazard to helicopters should be readily visible from the air. If a paint scheme is necessary to enhance identification by day, alternate black and white, black and yellow, or red and white bands are recommended, not less than 0.5 metres nor more than six metres wide. The colour should be chosen to contrast with the background to the maximum extent. Paint colours should conform to the references at paragraph 2.11.
- 4.2 Obstacles to be marked in these contrasting colours include any lattice tower structures and crane booms which are close to the helideck or the LOS boundary. Similarly, parts of the leg or legs of jack-up units adjacent to the landing area which extend, or can extend, above it should also be marked in the same manner.

- 4.3 Omnidirectional low intensity steady red obstruction lights conforming to the specifications for low intensity obstacle (Group A) lights described in *CAP 168 Licensing of Aerodromes*, Chapter 4 and Table 6A.1, having a minimum intensity of 10 candelas for angles of elevation between 0 degrees and 30 degrees should be fitted at suitable locations to provide the helicopter pilot with visual information on the proximity and height of objects which are higher than the landing area and which are close to it or to the LOS boundary. This should apply, in particular, to all crane booms on the installation. Objects which are more than 15 metres higher than the landing area should be fitted with intermediate low intensity steady red obstruction lights of the same intensity spaced at 10-metre intervals down to the level of the landing area (except where such lights would be obscured by other objects). It is often preferable for some structures such as flare booms and towers to be illuminated by floodlights as an alternative to fitting intermediate steady red lights, provided that the lights are arranged such that they will illuminate the whole of the structure and not dazzle the helicopter pilot. Such arrangements should be discussed with the helicopter operator. Offshore duty holders may, where appropriate, consider alternative equivalent technologies to highlight dominant obstacles in the vicinity of the helideck.
- 4.4 An omni-directional low intensity steady red obstruction light should be fitted to the highest point of the installation. The light should conform to the specifications for a low intensity obstacle (Group B) light described in *CAP 168 Licensing of Aerodromes*, Chapter 4 and Table 6A.1, having a minimum intensity of 50 candelas for angles of elevation between 0 and 15 degrees, and a minimum intensity of 200 candelas between 5 and 8 degrees. Where it is not practicable to fit a light to the highest point of the installation (e.g. on top of flare towers) the light should be fitted as near to the extremity as possible.
- 4.5 In the particular case of jack-up units, it is recommended that when the tops of the legs are the highest points on the installation, they should be fitted with omni-directional low intensity steady red lights of the same intensity and characteristics as described in paragraph 4.4. In addition the leg or legs adjacent to the helideck should be fitted with intermediate low intensity steady red lights of the same intensity and characteristics as described in paragraph 4.3 at 10-metre intervals down to the level of the landing area. As an alternative the legs may be floodlit providing the helicopter pilot is not dazzled.
- 4.6 Any ancillary structure within one kilometre of the landing area, and which is significantly higher than it, should be similarly fitted with red lights.
- 4.7 Red lights should be arranged so that the locations of the objects which they delineate are visible from all directions of approach above the landing area.
- 4.8 Installation/vessel emergency power supply design should include all forms of obstruction lighting. Any failures or outages should be reported immediately to the helicopter operator. The lighting should be fed from a UPS system.

# Chapter 5 Helideck Rescue and Fire Fighting Facilities

## 1 Introduction

- 1.1 This Chapter sets out the requirements regarding provision of equipment, extinguishing media, personnel, training, and emergency procedures for offshore helidecks on installations and vessels.

## 2 Key Design Characteristics – Principal Agent

- 2.1 A key aspect in the successful design for providing an efficient, integrated helideck rescue and fire fighting facility is a complete understanding of the circumstances in which it may be expected to operate. A helicopter accident, which results in a fuel spillage with wreckage and/or fire and smoke, has the capability to render some of the equipment inventory unusable or preclude the use of some passenger escape routes.
- 2.2 Delivery of fire fighting media to the landing area at the appropriate application rate should be achieved in the quickest possible time. The CAA strongly recommends that a delay of less than 15 seconds, measured from the time the system is activated to actual production at the required application rate, should be the objective. The operational objective should ensure that the system is able to bring under control a helideck fire associated with a crashed helicopter within 30 seconds measured from the time the system is producing foam at the required application rate for the range of weather conditions prevalent for the UKCS.
- NOTE:** A fire is deemed to be 'under control' at the point when it becomes possible for the occupants of the helicopter to be effectively rescued by trained fire-fighters.
- 2.3 Foam-making equipment should be of adequate performance and be suitably located to ensure an effective application of foam to any part of the landing area irrespective of the wind strength/direction or accident location when all components of the system are operating in accordance with the manufacturer's technical specifications for the equipment. However, for a Fixed Monitor System (FMS), consideration should also be given to the loss of a downwind foam monitor either due to limiting weather conditions or a crash situation occurring. The design specification for an FMS should ensure remaining monitors are capable of delivering finished foam to the landing area at or above the minimum application rate. For areas of the helideck or its appendages which, for any reason, may be otherwise inaccessible to an FMS, it is necessary to provide additional hand-controlled foam branch pipes as described in paragraph 2.9.
- 2.4 Consideration should be given to the effects of the weather on static equipment. All equipment forming part of the facility should be designed to withstand protracted exposure to the elements or be protected from them. Where protection is the chosen option, it should not prevent the equipment being brought into use quickly and effectively (see paragraph 2.2). The effects of condensation on stored equipment should be considered.
- 2.5 The minimum capacity of the foam production system will depend on the D-value of the helideck, the foam application rate, discharge rates of installed equipment and the expected duration of application. It is important to ensure that the capacity of the main helideck fire pump is sufficient to guarantee that finished foam can be applied at the appropriate induction ratio and application rate and for the minimum duration to the whole of the landing area when all helideck monitors are being discharged simultaneously.

- 2.6 The application rate is dependent on the types of foam concentrate in use and the types of foam application equipment selected. For fires involving aviation kerosene, ICAO has produced a performance test which assesses and categorises the foam concentrate. Most foam concentrate manufacturers will be able to advise on the performance of their concentrate against this test. The CAA recommends that foam concentrates compatible with seawater and meeting at least performance level 'B' are used. Level B foams should be applied at a minimum application rate of 6.0 litres per square metre per minute.
- 2.6.1 **Calculation of Application Rate:** Example for a D-value 22.2 metre helideck. Application rate =  $6.0 \times \pi \times r^2$  ( $6.0 \times 3.142 \times 11.1 \times 11.1$ ) = 2322 litres per minute.
- NOTE:** In the near future ICAO Annex 14 Volume I will sanction the use of performance level C foams which are more efficient in their extinguishing ability than level B foams. It is established that the application rate for foam meeting performance level C may be reduced to 3.75 litres per square metre per minute.
- 2.7 Given the remote location of helidecks the overall capacity of the foam system should exceed that necessary for initial extinction of any fire. Five minutes' discharge capability is generally considered by the CAA to be reasonable.
- 2.7.1 **Calculation of Minimum Operational Stocks:** Using the 22.2 metre example as shown in paragraph 2.6.1, a 1% foam solution discharged over five minutes at the minimum application rate will require  $2322 \times 1\% \times 5 = 116$  litres of foam concentrate. A 3% foam solution discharged over five minutes at the minimum application rate will require  $2322 \times 3\% \times 5 = 348$  litres of foam concentrate.
- NOTE:** Sufficient reserve foam stocks to allow for replenishment as a result of operation of the system during an incident, or following training or testing, will also need to be held.
- 2.8 Low expansion foam concentrates can generally be applied in either aspirated or un-aspirated form. It should be recognised that whilst un-aspirated foam may provide a quick knockdown of any fuel fire, aspiration, i.e. induction of air into the foam solution by monitor or by hand-controlled foam branch (see below), gives enhanced protection after extinguishment. Wherever non-aspirated foam equipment is selected during design, additional equipment capable of producing aspirated foam for post-fire security/control should be provided.
- 2.9 Not all fires are capable of being accessed by monitors and on some occasions the use of monitors may endanger passengers. Therefore, in addition to a fixed foam system monitor, there should be the ability to deploy at least two deliveries with hand-controlled foam branch pipes for the application of aspirated foam at a minimum rate of 225 litres/min through each hose line. A single hose line, capable of delivering aspirated foam at a minimum application rate of 225 litres/min, may be acceptable where it is demonstrated that the hose line is of sufficient length, and the hydrant system of sufficient operating pressure, to ensure the effective application of foam to any part of the landing area irrespective of wind strength or direction. The hose line(s) provided should be capable of being fitted with a branch pipe capable of applying water in the form of a jet or spray pattern for cooling, or for specific fire fighting tactics. Where a Deck Integrated Fire Fighting System (DIFFS) capable of delivering foam and/or seawater in a spray pattern to the whole of the landing area (see paragraphs 2.10 to 2.12 and Note below) is selected in lieu of an FMS, the provision of additional hand-controlled foam branch pipes may not be necessary to address any residual fire situation. Instead any residual fire may be tackled with the use of hand-held extinguishers (see paragraph 4).

- 2.10 As an effective alternative to an FMS, offshore duty holders are strongly encouraged to consider the provision of a DIFFS. These systems typically consist of a series of 'pop-up' nozzles, with both a horizontal and vertical component, designed to provide an effective spray distribution of foam to the whole of the landing area and protection for the helicopter for the range of weather conditions prevalent on the UKCS. A DIFFS should be capable of supplying performance level B or level C foam solution to bring under control a fire associated with a crashed helicopter within the time constraints stated in paragraph 2.2 achieving an average (theoretical) application rate over the entire landing area (based on the D-circle) of 6.0 litres per square metre per minute for level B foams or 3.75 litres per square metre per minute for level C foams, for a duration which at least meets the minimum requirements stated in paragraph 2.7.
- 2.11 The precise number and layout of pop-up nozzles will be dependent on the specific helideck design, particularly the dimensions of the critical area. However, nozzles should not be located adjacent to helideck egress points as this may hamper quick access to the helideck by trained rescue crews and/or impede occupants of the helicopter escaping to a safe place beyond the helideck. Notwithstanding this, the number and layout of nozzles should be sufficient to provide an effective spray distribution of foam over the entire landing area with a suitable overlap of the horizontal element of the spray pattern from each nozzle assuming calm wind conditions. It is recognised in meeting the objective for the average (theoretical) application rate specified in paragraph 2.10 for performance level B or C foams that there may be some areas of the helideck, particularly where the spray patterns of nozzles significantly overlap, where the average (theoretical) application rate is exceeded in practice. Conversely for other areas of the helideck the application rate in practice may fall below the average (theoretical) application rate specified in paragraph 2.10. This is acceptable provided that the actual application rate achieved for any portion of the landing area does not fall below two-thirds of the rates specified in paragraph 2.10 for the critical area calculation.
- NOTE:** Where a DIFFS is used in tandem with a passive fire-retarding system demonstrated to be capable of removing significant quantities of unburned fuel from the surface of the helideck in the event of a fuel spill from a ruptured aircraft tank, it is permitted to select a seawater-only DIFFS to deal with any residual fuel burn. A seawater-only DIFFS should meet the same application rate and duration as specified for a performance level B foam DIFFS in paragraphs 2.10 and 2.11. (See also paragraph 5 for NUIs.)
- 2.12 In a similar way to where an FMS is provided (see paragraph 2.3), the performance specification for a DIFFS needs to consider the likelihood that one or more of the pop-up nozzles may be rendered ineffective by the impact of a helicopter on the helideck. Any local damage to the helideck, nozzles and distribution system caused by a helicopter crash should not unduly hinder the system's ability to deal effectively with a fire situation. To this end a DIFFS supplier should be able to verify that the system remains fit for purpose, in being able to bring a helideck fire associated with a crashed helicopter "under control" within 30 seconds measured from the time the system is producing foam at the required application rate for the range of weather conditions prevalent for the UKCS (see also paragraph 2.2).
- 2.13 If life saving opportunities are to be maximised it is essential that all equipment should be ready for immediate use on, or in the immediate vicinity of, the helideck whenever helicopter operations are being conducted. All equipment should be located at points having immediate access to the landing area. The location of the storage facilities should be clearly indicated.

### 3 Use and Maintenance of Foam Equipment

- 3.1 Mixing of different concentrates in the same tank, i.e. different either in make or strength, is generally unacceptable. Many different strengths of concentrate are on the market. Any decision regarding selection should take account of the design characteristics of the foam system. It is important to ensure that foam containers and tanks are correctly labelled.
- 3.2 Induction equipment ensures that water and foam concentrate are mixed in the correct proportions. Settings of adjustable inductors, if installed, should correspond with strength of concentrate in use.
- 3.3 All parts of the foam production system, including the finished foam, should be tested by a competent person on commissioning and annually thereafter. The tests should assess the performance of the system against original design expectations while ensuring compliance with any relevant pollution regulations. Further information for testing of helideck foam production systems is stated in HSE OIS 6/2011, issued August 2011.

### 4 Complementary Media

- 4.1 While foam is considered the principal medium for dealing with fires involving fuel spillages, the wide variety of fire incidents likely to be encountered during helicopter operations – e.g. engine, avionic bays, transmission areas, hydraulics – may require the provision of more than one type of complementary agent. Dry powder and gaseous agents are generally considered acceptable for this task. The complementary agents selected should comply with the appropriate specifications of the ISO. Systems should be capable of delivering the agents through equipment which will ensure effective application.

**NOTE:** Halon extinguishing agents are no longer specified for new installations. Gaseous agents, including CO<sub>2</sub>, have replaced them. The effectiveness of CO<sub>2</sub> is accepted as being half that of halon.

- 4.2 The CAA recommends the use of dry powder as the primary complementary agent. The minimum total capacity should be 45 kg delivered from one or two extinguishers. The dry powder system should have the capacity to deliver the agent anywhere on the landing area and the discharge rate of the agent should be selected for optimum effectiveness of the agent. Containers of sufficient capacity to allow continuous and sufficient application of the agent should be provided.
- 4.3 The CAA recommends the use of a gaseous agent in addition to the use of dry powder as the primary complementary agent. Therefore, in addition to dry powder specified at paragraph 4.2, there should be a quantity of gaseous agent provided with a suitable applicator for use on engine fires. The appropriate minimum quantity delivered from one or two extinguishers is 18 kg. The discharge rate of the agent should be selected for optimum effectiveness of the agent. Due regard should be paid to the requirement to deliver gaseous agents to the seat of the fire at the recommended discharge rate. Because of the weather conditions prevalent on the UKCS, all complementary agents could be adversely affected during application and training evolutions should take this into account.
- 4.4 All offshore helicopters have integral engine fire protection systems (predominantly halon) and it is therefore considered that provision of foam as the principal agent plus suitable water/foam branch lines plus sufficient levels of dry powder with a quantity of secondary gaseous agent will form the core of the fire extinguishing system. It should be borne in mind that none of the complementary agents listed will offer any post-fire security/control.



- 4.5 All applicators are to be fitted with a mechanism which allows them to be hand controlled.
- 4.6 Dry chemical powder should be of the 'foam compatible' type.
- 4.7 The complementary agents should be sited so that they are readily available at all times.
- 4.8 Reserve stocks of complementary media to allow for replenishment as a result of activation of the system during an incident, or following training or testing, should be held.
- 4.9 Complementary agents should be subject to annual visual inspection by a competent person and pressure testing in accordance with manufacturers' recommendations.

## 5 Normally Unattended Installations

**NOTE:** The criteria given in paragraphs 5.1 to 5.3 address current best practice criteria for new-build NUIs. For existing NUI assets located on the UKCS a number of specific options have been disseminated to industry in the form of a letter dated 1 July 2011. This letter is reproduced in CAP 437 in Appendix D.

- 5.1 In the case of new-build NUIs, serious consideration should be given to the selection and provision of foam as the principal agent. For an NUI, where helideck Rescue and Fire Fighting (RFF) equipment will be unattended during certain helicopter movements, the pressurised discharge of foam through a manually operated fixed monitor system is not recommended. For installations which are at times unattended the effective delivery of foam to the whole of the landing area is probably best achieved by means of a DIFFS. See paragraphs 2.10 to 2.12.
- 5.2 For NUIs the CAA may also consider other 'combination solutions' where these can be demonstrated to be effective in dealing with a running fuel fire. This may permit, for example, the selection of a seawater-only DIFFS used in tandem with a passive fire-retarding system demonstrated to be capable of removing significant quantities of unburned fuel from the surface of the helideck in the event of a fuel spill from a ruptured aircraft tank.
- 5.3 DIFFS on NUIs should be integrated with platform safety systems such that pop-up nozzles are activated automatically in the event of an impact of a helicopter on the helideck where a Post-Crash Fire (PCF) is a foreseeable outcome. The overall design of a DIFFS should incorporate a method of fire detection and be configured to avoid spurious activation. It should be capable of manual over-ride by the HLO and from the mother installation or from an onshore control room. Similar to a DIFFS provided for a Permanently Attended Installation (PAI) or vessel, a DIFFS provided on an NUI needs to consider the eventuality that one or more nozzles may be rendered ineffective by, for example, a crash. The basic performance assumptions stated in paragraphs 2.10 to 2.12 should also apply for a DIFFS located on an NUI.

## 6 The Management of Extinguishing Media Stocks

- 6.1 Consignments of extinguishing media should be used in delivery order to prevent deterioration in quality by prolonged storage.
- 6.2 The mixing of different types of foam concentrate may cause serious sludging and possible malfunctioning of foam production systems. Unless evidence to the contrary is available it should be assumed that different types are incompatible. In these circumstances it is essential that the tank(s), pipework and pump (if fitted) are thoroughly cleaned and flushed prior to the new concentrate being introduced.

- 6.3 Consideration should be given to the provision of reserve stocks for use in training, testing and recovery from emergency use.

## 7 Rescue Equipment

- 7.1 In some circumstances, lives may be lost if simple ancillary rescue equipment is not readily available.
- 7.2 The CAA strongly recommends the provision of at least the following equipment. Sizes of equipment are not detailed but should be appropriate for the types of helicopter expected to use the facility.

**Table 1** Rescue Equipment

Helicopter RFF Category		
	H1/H2	H3
Adjustable wrench	1	1
Rescue axe, large (non wedge or aircraft type)	1	1
Cutters, bolt	1	1
Crowbar, large	1	1
Hook, grab or salving	1	1
Hacksaw (heavy duty) and six spare blades	1	1
Blanket, fire resistant	1	1
Ladder (two-piece)*	1	1
Life line (5 cm circumference x 15 m in length) plus rescue harness	1	1
Pliers, side cutting (tin snips)	1	1
Set of assorted screwdrivers	1	1
Harness knife and sheath**	**	**
Gloves, fire resistant**	**	**
Power cutting tool	–	1

\* For access to casualties in an aircraft on its side.

\*\* This equipment is required for each helideck crew member.

- 7.3 A responsible person should be appointed to ensure that the rescue equipment is checked and maintained regularly. Rescue equipment should be stored in clearly marked and secure watertight cabinets or chests. An inventory checklist of equipment should be held inside each equipment cabinet/chest.

## 8 Personnel Levels

- 8.1 The facility should have sufficient trained fire fighting personnel immediately available whenever aircraft movements are taking place. They should be deployed in such a way as to allow the appropriate fire fighting and rescue systems to be operated efficiently and to maximum advantage so that any helideck incident can be managed effectively. The HLO should be readily identifiable to the helicopter crew as the person in charge of helideck operations. The preferred method of identification is a brightly coloured 'HLO' tabard. For guidance on helideck crew composition refer to the OGUK Guidelines for the Management of Aviation Operations.

## **9 Personal Protective Equipment (PPE)**

- 9.1 All responding rescue and fire fighting personnel should be provided with appropriate PPE to allow them to carry out their duties in an effective manner.
- 9.2 Sufficient personnel to operate the RFF equipment effectively should be dressed in protective clothing prior to helicopter movements taking place.
- 9.3 For the selection of appropriate PPE account should be taken of the Provision and Use of Work Equipment Regulations (PUWER) and the Personal Protective Equipment at Work Regulations (PPEWR), which require equipment to be suitable and safe for intended use, maintained in a safe condition and (where appropriate) inspected to ensure it remains fit for purpose. In addition, equipment should only be used by personnel who have received adequate information, instruction and training. PPE should be accompanied by suitable safety measures (e.g. protective devices, markings and warnings). Appropriate PPE should be determined through a process of risk assessment.
- 9.4 A responsible person(s) should be appointed to ensure that all PPE is installed, stored, used, checked and maintained in accordance with the manufacturer's instructions.

## **10 Training**

- 10.1 If they are to effectively utilise the equipment provided, all personnel assigned to RFF duties on the helideck should be fully trained to carry out their duties to ensure competence in role and task. The CAA recommends that personnel attend an established helicopter fire fighting course.
- 10.2 In addition, regular training in the use of all RFF equipment, helicopter familiarisation and rescue tactics and techniques should be carried out. Correct selection and use of principal and complementary media for specific types of incident should form an integral part of personnel training.

## **11 Emergency Procedures**

- 11.1 The installation or vessel emergency procedures manual should specify the actions to be taken in the event of an emergency involving a helicopter on or near the installation or vessel. Exercises designed specifically to test these procedures and the effectiveness of the fire fighting teams should take place at regular intervals.

## **12 Further Advice**

- 12.1 Advice is available from the CAA's Aerodrome Standards Department regarding the choice and specification of fire extinguishing agents.

INTENTIONALLY LEFT BLANK

# Chapter 6 Helicopter Landing Areas – Miscellaneous Operational Standards

## 1 Landing Area Height above Water Level

- 1.1 In consideration of the effects upon aircraft performance in the event of an engine failure (see Chapter 2) the height of the landing area above water level will be taken into account when deciding on any operational limitations to be applied to specific helidecks. Landing area height above water level is to be included in the information supplied on the helideck template for the purpose of authorising the use of the helideck (see Appendix A).

## 2 Wind Direction (Vessels)

- 2.1 The ability of a vessel to manoeuvre may be helpful in providing an acceptable wind direction in relation to the helideck location and information provided should include whether the installation or vessel is normally fixed at anchor, single point moored, or semi- or fully manoeuvrable.

## 3 Helideck Movement

- 3.1 Floating installations and vessels experience dynamic motions due to wave action which represent a potential hazard to helicopter operations. Operational limitations are therefore set by the helicopter operators which are promulgated in the HLL and incorporated in their Operations Manuals. Helideck downtime due to excessive deck motion can be minimised by careful consideration of the location of the helideck on the installation or vessel at the design stage. Guidance on helideck location and how to assess the impact of the resulting helideck motion on operability is presented in CAA Paper 2008/03 'Helideck Design Considerations – Environmental Effects' which is available on the Publications section of the CAA website at [www.caa.co.uk](http://www.caa.co.uk). It is strongly recommended that mobile installation and vessel designers consult CAA Paper 2008/03 at the earliest possible stage of the design process.
- 3.2 The helideck approval will be related to the helicopter operator's Operations Manual limitations regarding the movement of the helideck in pitch and roll, helideck inclination, Significant Heave Rate (SHR) and vessel heading. It is necessary for details of these motions to be recorded by the vessel's Helideck Motion System (HMS) and reported as part of the overall Offshore Weather Report (see Appendix E) prior to, and during, all helicopter movements. A colour indication should be displayed on the HMS to indicate whether the deck is 'in limits' for approach to land (BLUE (or GREEN) = deck safe for landing) or whether 'out of limits' for approach to land (RED = nil landing).
- 3.3 Pitch and roll reports to helicopters should include values, in degrees, about both axes of the true vertical datum (i.e. relative to the true horizon) and be expressed in relation to the vessel's heading. Roll should be expressed in terms of 'left' and 'right'; pitch should be expressed in terms of 'up' and 'down'; helideck inclination is the angle measured in degrees between the absolute horizon and the plane of the helideck. SHR, being twice the Root Mean Square (RMS) heave rate measured over a 20-minute period, should be reported in metres per second. Values of pitch and roll, helideck inclination and SHR should be reported to one decimal place.

- 3.3.1 The helicopter pilot is concerned, in order to make vital safety decisions, with the amount of 'slope' on, and the rate of movement of, the helideck surface. It is therefore important that reported values are only related to the true vertical and do not relate to any 'false' datum (i.e. a 'list') created, for example, by anchor patterns or displacement.
- 3.3.2 Reporting Format: A standard radio message should be passed to the helicopter which contains the information on helideck movement in an unambiguous format. This will, in most cases, be sufficient to enable the helicopter flight crew to make safety decisions. Should the helicopter flight crew require other motion information or amplification of the standard message, the crew will request it (for example, yaw and heading information). For further guidance refer to CAP 413 Radiotelephony Manual.
- 3.3.3 **Standard Report Example:**
- Situation:** The maximum vessel movement (over the preceding 20-minute period) about the roll axis is 1.6° to port and 3.6° to starboard (i.e. this vessel may have a permanent list of 1° to starboard and is rolling a further 2.6° either side of this 'false' datum). The maximum vessel movement (over the preceding 20-minute period) about the pitch axis is 2.1° up and 2.3° down. The maximum helideck inclination is 2.8°. The SHR recorded over the preceding 20-minute period is 1.1 metres per second.
- Report:** "Roll 1.6° left and 3.6° right; pitch 2.1° up and 2.3° down; maximum helideck inclination 2.8°; Significant Heave Rate 1.1 metres per second".
- NOTE:** For helicopter operations on the UKCS, the long-standing helideck heave limitation was replaced by a measurement of heave rate in November 2010. Heave rate is considered a more appropriate parameter and has been used in the Norwegian sector for many years. The measure of heave rate recommended (SHR) is different to that previously used in the Norwegian sector (Maximum Average Heave Rate (MAHR)) and will be described in a future CAA Paper. Although it requires electronic motion-sensing equipment to generate it, SHR provides a simpler, less ambiguous and more representative measure of heave rate than MAHR. It is intended that the SHR criterion will be introduced ahead of the formal implementation of the new helideck motion-sensing scheme mentioned in paragraph 3.4. However, following early evaluations, an operational issue with the variability of SHR has been identified which is being addressed. It is expected that it will have been resolved by the time this seventh edition of CAP 437 is published.
- 3.4 Current research has indicated that the likelihood of a helicopter tipping or sliding on a moving helideck is directly related to helideck accelerations and to the prevailing wind conditions. It is therefore intended that future requirements will introduce additional measuring and reporting criteria in the form of a Motion Severity Index (MSI) and a Wind Severity Index (WSI). The CAA is currently completing research into the definition of these parameters, and how operating limits in terms of these parameters should be set. A CAA paper fully describing the new scheme will be published when the research and in-service trials have been completed (estimated later in 2012). In the meantime, CAA Paper 2008/03 contains a top-level summary of the scheme in its trials form.
- 3.5 In earlier editions of CAP 437 it was noted that a small number of helideck motion reports to pilots were still based on visual estimations. While this practice is now very rare, it is nevertheless emphasised that this is not considered to be an acceptable way of obtaining vital safety information. It is therefore strongly recommended that all

moving helidecks are equipped with electronic motion-sensing systems which will not only facilitate implementation of the new scheme mentioned in paragraph 3.4, but also produce accurate pitch and roll, helideck inclination and SHR information to cater for current reporting requirements.

## 4 Meteorological Information

(Relevant references are listed in Appendix B.)

(Additional guidance is listed in Appendix E.)

4.1 Accurate, timely and complete meteorological observations are necessary to support safe and efficient helicopter operations.

### 4.2 Meteorological Observations

In addition to the data covered by paragraph 3, it is strongly recommended that installations are provided with an automated means of ascertaining the following meteorological information at all times:

- a) wind speed and direction (including variations in direction);
- b) air temperature and dew point temperature;
- c) QNH and, where applicable, QFE;
- d) cloud amount and height of base (Above Mean Sea Level (AMSL));
- e) visibility; and
- f) present weather.

- NOTES:**
1. Where an installation is within 10 nautical miles of another installation that is equipped with an automated means of ascertaining the meteorological information listed above, and which also makes this information routinely available to others, a manual means of verifying and updating the visual elements of observation, i.e. cloud amount and height of base, visibility and present weather, may be used.
  2. Contingency meteorological observing equipment providing manual measurements of air and dew point temperatures, wind speed and direction and pressure is recommended to be provided in case of the failure or unavailability of the automated sensors.

#### 4.2.1 Assessment of Wind Speed and Direction

For recording purposes an anemometer positioned in an unrestricted air flow is required. A second anemometer, located at a suitable height and position, can give useful information on wind velocity at hover height over the helideck in the event of turbulent or disturbed air flows over the deck. An indication of wind speed and direction should also be provided visually to the pilot by the provision of a wind sock coloured so as to give maximum contrast with the background (see also Chapter 4, paragraph 1.5).

### 4.3 Reporting of Meteorological Information

Up-to-date, accurate meteorological information is used by helicopter operators for flight planning purposes and by crews to facilitate the safe operation of helicopters in the take-off and landing phases of flight. Reports should be provided by the Met Observer at the platform concerned and not by Met Observers located on neighbouring platforms or from safety boats in the vicinity.

#### 4.3.1 Pre-Flight Weather Reports

The latest weather report from each installation should be made available to the helicopter operator one hour before take-off. These reports should contain:

- the name and location of the installation;
- the date and time the observation was made;
- wind speed and direction;
- visibility;
- present weather (including presence of lightning);
- cloud amount and height of base;
- temperature and dew point;
- QNH and QFE;
- SHR;
- pitch and roll; and
- helideck inclination.

Where measured, the following information may also be included in the weather report:

- significant wave height.

**NOTE:** Additional non-meteorological information may be required to be provided, e.g. fuelling installation, radio frequencies or passenger numbers.

#### 4.3.2 Radio Messages

A standard radio message should be passed to the helicopter operator which contains information on the helideck weather in a clear and unambiguous format. When passing weather information to flight crews it is recommended that the information be consistently sent in a standard order as detailed in CAP 413 'Radiotelephony Manual' and in the OGUK 'Guidelines for the Management of Aviation Operations'. This message will usually be sufficient to enable the helicopter crew to make informed safety decisions. Should the helicopter crew require other weather information or amplification of the standard message they will request it.

#### 4.4 Collection and Retention of Meteorological Information

Records of all meteorological reports that are issued are required to be retained for a period of at least 30 days.

##### 4.4.1 Real-Time Web-Based Systems

Offshore installations are strongly encouraged to supply meteorological information and weather report forms produced from the automated sensors to web-based systems that are operated on behalf of the UK offshore industry. These systems enable helicopter operators, installation duty holders and others to access the latest weather information in real time. Where appropriate, AUTO METARS may be generated from these reports which, provided all the required parameters are being generated, may be made available on the Aeronautical Fixed Service (AFS) channels, including the Aeronautical Fixed Telecommunications Network (AFTN).

#### 4.5 Meteorological Observer Training

The CAA recommends that personnel who carry out meteorological observations on offshore installations undergo formal meteorological observer training and are certificated by an approved training organisation for this role. Observers should complete refresher training every two years to ensure they remain familiar with any changes to meteorological observing practices and procedures.



#### 4.6 **Calibration of Meteorological Equipment Sensors**

Calibration of meteorological equipment sensors used to provide the data listed in paragraph 4.2 should be periodically calibrated in accordance with the manufacturers' recommendations in order to demonstrate continuing adequacy for purpose.

### 5 **Location in Respect to Other Landing Areas in the Vicinity**

5.1 Mobile installations and support vessels with helidecks may be positioned adjacent to other installations so that mutual interference/overlap of obstacle protected surfaces occur. Also on some installations there may be more than one helideck which may result in a conflict of obstacle protected surfaces.

5.2 Where there is conflict as mentioned above, within the OFS and/or falling gradient out to a distance that will allow for both an unobstructed departure path and safe clearance for obstacles below the helideck in the event of an engine failure for the type of helicopter the helideck is intended to serve (see also Glossary of Terms. Note: for helicopters operated in Performance Class 1 or 2 the horizontal extent of this distance from the helideck will be based upon the one-engine inoperative capability of the helicopter type to be used), simultaneous operation of two helicopter landing areas is not to take place without prior consultation with the helicopter operator. It is possible, depending upon the distance between landing areas and the operational conditions which may pertain, that simultaneous operations can be permitted but suitable arrangements for notification of helicopter crews and other safety precautions will need to be established. In this context, 'flotels' will be regarded in the same way as any other mobile installation which may cause mutual interference with the parent installation approach and take-off sector. For a detailed treatment of this subject readers are recommended to refer to the OGUK 'Guidelines for the Management of Aviation Operations'. See also Chapter 3 which addresses issues from the perspective of the impact of environmental effects on helideck operations.

### 6 **Control of Crane Movement in the Vicinity of Landing Areas**

6.1 Cranes can adversely distract pilots' attention during helicopter approach and take-off from the helideck as well as infringe fixed obstacle protected surfaces. Therefore it is essential that when helicopter movements take place ( $\pm 5$  minutes) crane work ceases and jibs, 'A' frames, etc. are positioned clear of the obstacle protected surfaces and flight paths.

6.2 The HLO should be responsible for the control of cranes in preparation for and during helicopter operations.

### 7 **General Precautions**

7.1 Whenever a helicopter is stationary on board an offshore installation with its rotors turning, except in case of emergency, no person should enter upon or move about the helicopter landing area otherwise than within view of a helicopter flight crew member or the HLO and at a safe distance from its engine exhausts and tail rotor. It may also be dangerous to pass under the main rotor disc in front of helicopters which have a low main rotor profile.

7.2 The practical implementation of paragraph 7.1 is best served through consultation with the helicopter operator for a clear understanding of the approach paths approved for personnel and danger areas associated with a rotors-running helicopter. These

areas are type-specific but, in general, the approved routes to and from the helicopter are at the 2–4 o'clock and 8–10 o'clock positions. Avoidance of the 12 o'clock (low rotor profile helicopters) and 6 o'clock (tail rotor danger areas) positions should be maintained.

- 7.3 Personnel should not approach the helicopter while the helicopter anti-collision (rotating/flashing) beacons are operating. In the offshore environment, the helideck should be kept clear of all personnel while anti-collision lights are on.

## **8 Installation/Vessel Helideck Operations Manual and General Requirements**

- 8.1 The maximum helicopter mass and D-value for which the deck has been designed and the maximum size and weight of helicopter for which the installation is certified should be included in the Operations Manual. The extent of the obstacle-free area should also be stated and reference made to any helideck operating limitation imposed by helicopter operators as a result of any non-compliance. Non-compliances should also be listed.

## **9 Helicopter Operations Support Equipment**

- 9.1 Provision should be made for equipment needed for use in connection with helicopter operations including:
- a) chocks and tie-down strops/ropes (strops are preferable);
  - b) heavy-duty, calibrated, accurate scales for passenger baggage and freight weighing;
  - c) a suitable power source for starting helicopters if helicopter shut-down is seen as an operational requirement; and
  - d) equipment for clearing the helicopter landing area of snow and ice and other contaminants.
- 9.2 Chocks should be compatible with helicopter undercarriage/wheel configurations. Helicopter operating experience offshore has shown that the most effective chock for use on helidecks is the 'NATO sandbag' type. Alternatively, 'rubber triangular' or 'single piece fore and aft' type chocks may be used as long as they are suited to all helicopters likely to operate to the helideck. The 'rubber triangular' chock is generally only effective on decks without nets.
- 9.3 For securing helicopters to the helideck it is recommended that adjustable tie-down strops are used in preference to ropes. Specifications for tie-downs should be agreed with the helicopter operators.
- 9.4 Detailed guidance on the provision and operation of aeronautical communications and navigation facilities associated with offshore helicopter landing areas is given in the OGUK publications 'Guidelines for the Management of Aviation Operations' and 'Guidelines for Safety Related Telecommunications Systems On Fixed Offshore Installations'.

- 9.5 Offshore Radio Operators, HLOs, Helideck Assistants and other persons who operate VHF aeronautical radio equipment are required to hold a UK CAA Offshore Aeronautical Radio Station Operator's Certificate of Competence. Further information can be found in CAP 452 'Aeronautical Radio Station Operator's Guide' and CAP 413 'Radiotelephony Manual' which can be found on the CAA website at [www.caa.co.uk/cap452](http://www.caa.co.uk/cap452) and [www.caa.co.uk/cap413](http://www.caa.co.uk/cap413).
- 9.6 Offshore fixed installations, mobile installations and vessels which have aeronautical radio equipment and/or aeronautical Non-Directional Radio Beacons (NDBs) installed on them and are operating in UK Internal Waters, UK Territorial Waters or within the limits of the UKCS are required to hold a valid Wireless Telegraphy (WT) Act licence and Air Navigation Order (ANO) approval. The UK CAA Form SRG 1417 'Application to Establish or Change an Aeronautical Ground Radio Station' may be used to apply for both the WT Act licence and ANO approval and can be found on the CAA website at [www.caa.co.uk/srg1417](http://www.caa.co.uk/srg1417).
- 9.7 The UK Office of Communications (Ofcom) has an agreement with the UK CAA, Directorate of Airspace Policy (DAP), Surveillance and Spectrum Management (S&SM) to administer WT Act licences for aircraft, aeronautical (ground) radio stations and navigation aids on their behalf. Further information can be found on the CAA website at [www.caa.co.uk/radiolicensing](http://www.caa.co.uk/radiolicensing).

INTENTIONALLY LEFT BLANK

# Chapter 7 Helicopter Fuelling Facilities – Systems Design and Construction

## 1 General

- 1.1 The contents of this chapter are intended as general advice/best practice for the design and construction requirements for helicopter fuelling systems intended for use on offshore installations and vessels. The information has been compiled by OGUK in consultation with the UK offshore oil and gas industry and specialist fuelling companies.
- 1.2 This chapter has been prepared with the relevant content of CAP 748 'Aircraft Fuelling and Fuel Installation Management' in mind. However, supplementary detailed information can be obtained from CAP 748 and aviation fuel suppliers. Where the reader is referred to other standards or alternative guidance, the reference documents used should always be checked by the reader to ensure they are up-to-date and reflect current best practice.

## 2 Product Identification

- 2.1 It is essential to ensure at all times that aviation fuel delivered to helicopters from offshore installations and vessels is of the highest quality. A major contributor toward ensuring that fuel quality is maintained and contamination is prevented is to provide clear and unambiguous product identification on all system components and pipelines denoting the fuel type (e.g. Jet A-1) following the standard aviation convention for markings and colour code. Details can be found in API/IP Standard 1542 'Identification markings for dedicated aviation fuel manufacturing and distribution facilities, airport storage and mobile fuelling equipment'. The correct identification markings should initially be applied during system manufacture and routinely checked for clarity during subsequent maintenance inspections.

## 3 Fuelling System Description

- 3.1 It should be noted that an offshore fuelling system may vary according to the particular application for which it was designed. Nevertheless the elements of all offshore fuelling systems are basically the same and generally include:
- a) transit tanks;
  - b) static storage facilities and, if installed, a sample reclaim tank (see Note);
  - c) a pumping system; and
  - d) a delivery system.

**NOTE:** In some systems where built-in static storage tanks are not provided, delivery of fuel directly to the aircraft from transit tanks is acceptable. In this case, sample reclaim tanks should not be used.

### 3.2 General Design Considerations

- 3.2.1 When preparing a layout design for aviation fuelling systems on offshore installations and vessels it is important to make provisions for suitable segregation and bunding of the areas set aside for the tankage and delivery system. Facilities for containing

possible fuel leakage and providing fire control should be given full and proper consideration, along with adequate protection from potential dropped objects (e.g. due to crane operations).

### 3.3 Transit Tanks

- 3.3.1 Transit tanks should be constructed to satisfy the requirements of Intergovernmental Marine Consultative Organisation (IMCO) and International Maritime Dangerous Goods (IMDG) Codes and current inspection and repair codes of practice.
- 3.3.2 Tanks may be constructed from stainless steel or mild steel. If mild steel is used, then the tanks should be lined with suitable fuel-resistant epoxy lining.
- 3.3.3 The tanks should be encased in a robust steel cage with four main lifting eyes and, where possible, stainless steel fasteners in conjunction with stainless steel fittings should be used. The tank frame should incorporate cross-members to provide an integral 'ladder' access to the tank top. When horizontal vessels are mounted in the transit frame there should be a tank centre line slope towards a small sump. Vertical vessels should have dished ends providing adequate drainage towards the sump. This slope should be at least 1 in 30, although 1 in 25 is preferred.
- 3.3.4 Tanks should be clearly and permanently marked on the identification plate with the tank capacity and tank serial number. Tanks should also be clearly marked with the date of the last lifting gear inspection and initial/last IMDG test.
- 3.3.5 Tanks should normally be equipped with the following:
- a) **Manhole.** A 450 mm (18") or greater manhole to allow physical access to the interior of the tank.
  - b) **Inspection Hatch.** If the manhole position and/or cover type is unsuitable for inspecting the lower end of the tank, a 150 mm (6") hatch should be fitted to enable inspection.
  - c) **Dipstick Connection.** A suitable captive dipstick to determine the tank contents.
  - d) **Emergency Pressure Relief.** A stainless steel 63.5 mm (2½") pressure/vacuum relief valve fitted with weatherproof anti-flash cowl. The valve settings will depend on the type of tank in use and manufacturers' recommendations should be followed.
  - e) **Sample Connection.** A stainless steel sample point, fitted at the lowest point of the tank. A foot-valve should be fitted in the sample line, complete with an extension pipe terminating with a ball valve with a captive dust cap. Sample lines should be a minimum of 20 mm (¾") diameter but preferably 25.4 mm (1") diameter. In order to allow a standard four-litre sample jar to be used, the sample point should be designed with sufficient access, space and height to accommodate the jars.
  - f) **Outlet/Fill Connection.** The outlet/fill connection should be a flanged fitting with a 76 mm (3") internal valve terminating to a 63.5 mm (2½") self-sealing coupler complete with captive dust cap. The draw-off point for the tank outlet should be at least 150 mm (6") higher than the lowest point of the tank.
  - g) **Document Container.** A suitably robust container should be positioned close to the fill/discharge point to hold the tank and fuel certification documents.
  - h) **Tank Barrel and Frame External Surface Finishes.** The tank barrel and frame should be suitably primed and then finished in safety yellow (BS 4800, Type 08.E.51). Where the barrel is fabricated from stainless steel it may remain unpainted. Safety yellow is not mandatory but has been generally accepted for

helifuel tanks. All component parts, e.g. tank, frame etc., should be properly bonded before being painted. Whether the tank barrel is painted yellow or otherwise, Jet A-1 Transit Tanks should be correctly identified by placing clear product identification markings on all sides, particularly above the tank filling and dispensing attachment.

- i) **Tank Shell Internal Finish.** The internal finish should be sufficiently smooth to ensure that liquid run-off is clean and allow the tank to be wiped down during internal inspections without dragging threads or lint from the cleaning cloth.

### 3.4 Static Storage Tanks

- 3.4.1 Where static storage tanks are provided they should be constructed to suitable standards. Acceptable standards include ASME VIII and BS 5500 Categories I, II and III. The tank should be cylindrical and mounted with an obstacle free centre line slope (e.g. no baffles fitted) to a small sump. This slope should be at least 1 in 30, although 1 in 25 is preferred.
- 3.4.2 Tanks may be constructed from stainless steel or mild steel. If mild steel is used, then the tanks should be lined with a suitable white coloured, fuel-resistant epoxy surface finish.
- 3.4.3 The sump should be fitted with a sample line which has a double block valve arrangement and it should have a captive dustcap on the end to prevent the ingress of dirt or moisture.
- 3.4.4 Sample lines should be a minimum of 20 mm ( $\frac{3}{4}$ " ) diameter and preferably 25.4 mm (1" ) diameter. The sample point accessibility should be as described in paragraph 3.3.5(e).
- 3.4.5 Tanks should be clearly and permanently marked on the identification plate with the tank capacity and tank serial number.
- 3.4.6 Static tanks should be equipped with the following:
  - a) **Manhole.** A 450 mm (18" ) or greater diameter manhole which should normally be hinged to assist easy opening.
  - b) **Inspection Hatch.** A 150 mm (6" ) sample hatch to allow for a visual inspection of the low end of the tank, or for the taking of samples.
  - c) **Contents Measuring Device.** A suitable dipstick or dip-tape should be provided, with a means of access to the tank interior. Additionally, a sight glass or contents gauge may be provided to determine the tank contents.
  - d) **Vent.** A free vent or an emergency pressure/vacuum relief valve should be fitted. Type and pressure settings should be in accordance with the manufacturer's recommendations.
  - e) **Outlet/Fill Connection.** Separate outlet and fill connections with the fill point arranged so that there is no free-fall of product at any stage of the tank filling. The draw-off point for the tank should be at least 150 mm (6" ) higher than the lowest point of the tank or by means of floating suction.
  - f) **Floating Suction.** When floating suction is embodied then a bonded floating suction check wire pull assembly should be fitted directly to the top of the tank. Floating suction offers several advantages over other outlet types and is therefore strongly recommended.
  - g) **Automatic Closure Valves.** Automatic quick closure valves to the fill and discharge points should be fitted. These valves should be capable of operation from both the helideck and from another point which is at a safe distance from the tank.

- h) **Tank Shell Outer Surface Finish.** The static storage tank shell should be suitably primed and then finished in safety yellow (BS 4800, Type 08.E.51). Where the tank shell is fabricated from stainless steel it may remain unpainted. Safety yellow is not mandatory but has been generally accepted for helifuel tanks. All component parts should be properly bonded before being painted. Whether the tank barrel is painted yellow or otherwise, Jet A-1 static storage tanks should be correctly identified by placing clear product identification markings on all sides, particularly above the tank filling and dispensing attachment.
- i) **Tank Shell Inner Surface Finish.** The internal finish should be sufficiently smooth to ensure that liquid run-off is clean and allow the tank to be wiped down during internal inspections without dragging threads or lint from the cleaning cloth.

### 3.5 Sample Reclaim Tank

- 3.5.1 If the fuelling system includes a static storage tank, water-free and sediment-free fuel samples can be disposed of into a dedicated reclaim tank (if installed). The sample reclaim tank should be equipped with a removable 100 mesh strainer at the fill point, a lockable sealing lid, a conical base with a sample point at the sump and a return line (fitted with a check valve) to the storage tank via an EI 1581 approved filter water separator.
- 3.5.2 Where the system does not include a functioning static storage tank and fuelling is direct from transit tanks, if a sample reclaim tank has been installed fuel samples may be drained to it. However, the reclaim tank contents should only be decanted directly from the sample point into drums and then properly disposed of.

### 3.6 Delivery System

- 3.6.1 The delivery system to transfer fuel from storage tanks to the aircraft should include the following components:
  - a) **Pump.** Where practicable, systems should be designed to incorporate a twin pump skid in order to provide redundancy should one pump fail in service. This may not always be possible due to space restrictions. The pumps should be electrically or air driven, centrifugal or positive displacement types with a head and flow rate suited to the particular installation. The pump(s) should be able to deliver up to 225 litres (50 imperial gallons) per minute under normal flow conditions. A remote start/stop control should be provided on or immediately close to the helideck and close to the hose storage location (in a position where the operator is able to view the whole fuelling operation). Additionally there should be a local emergency stop control adjacent to the pump(s).

**NOTE:** Hand pumps should not be incorporated in refuelling system design and should be removed from existing systems where fitted. Lack of use over long periods of time may result in deterioration of the hand pumps' internal components, causing them to become a potential source of system contamination.

  - b) **Pump and Aircraft Bonding Safety Systems.** The pumping system should be equipped with an automatically switched, flashing pump-running warning beacon that is visible from the helideck to clearly show that the fuel delivery pumps are running. Ideally, the flashing beacon should be coloured amber to distinguish it from other helideck lighting and to ensure it is visible against the general installation lighting. The colour red should not be used. In addition, there should be an automatic interlock (e.g. an earth proving unit) that prevents the pump from running and the pump-running warning flashing until such time as there is positive earth bonding established between the aircraft and the refuelling system. For



operational reasons, it should be possible to run the system by earthing the interlock to something other than an aircraft in order to draw daily samples and carry out maintenance activities. The system should be robustly designed to prevent inadvertent disconnection during operation whilst at the same time ensuring 'breakaway device' integrity is maintained as temperamental operation may be a contributing factor to intentional by-pass of aircraft bonding during refuelling operations. In the event of an earth bonding fault occurring, the system should be designed such that 'steady-state' enunciator lights are extinguished at the dispensing cabinet (e.g. at the control panel) and a manual intervention is required prior to re-starting the pump. Although one side of the earth loop will be connected to the control circuit, the electrical resistance between the end connection of the second side of the loop and the system pipework should not be more than 0.5 ohms. The selected length of cable provided should be consistent with easily reaching the helicopter refuelling points when the aircraft is correctly positioned on the helideck. In the case of existing delivery systems an automatic 'earth proving' interlock should be installed, where it is practicable to do so; where this is not possible, an earth bonding cable should be fitted as detailed in paragraph 3.6.1(f).

**NOTE:** Regardless of the status of the automatic 'earth proving' interlock that prevents the pump from running and the pump-running warning beacon flashing, the flight crew/HLO remain responsible for ensuring that the bonding cable has been disconnected from the aircraft and properly stowed prior to clearance for flight (see also Chapter 8, paragraphs 9.2(f) and 9.2(g)).

- c) **Flow Meter.** The flow meter should be of the positive displacement type with a read-out in litres, positioned upstream of the filter water monitor or combined three-stage filter vessel and sized to suit the flow rate. System designs should take fully into consideration flow meter manufacturers' recommendations including the installation of strainers and air eliminators when appropriate, especially when placed before a combined three-stage filter vessel. In the case of existing flow meter systems installed downstream from the filter water monitor, consideration should be given to relocating the flow meter upstream, where it is practicable to do so. Alternatively, suitable controls (e.g. sample points) and procedures should be put in place to ensure that the system can be routinely monitored for entrained particulate matter.
- d) **Filtration.** System filtration should either consist of a two-vessel design, where first and second stage filtration takes place within a filter water separator vessel and third stage filtration takes place within a fuel monitor vessel, or alternatively a single vessel design may be used in the form of a combined three-stage filter vessel. Vessels should meet the following criteria:
- i) **Filter Water Separator.** Filter water separators should be fitted with an automatic air eliminator and pressure relief valve and sized to suit the discharge rate and pressure of the delivery system. Units should be EI 1581 approved (to the latest edition with reference to Joint Inspection Group (JIG) Aviation Fuel QC Bulletin No. 7) and such filters should provide protection down to 1 micron particle size or better. A differential pressure gauge with calibrated reading should be fitted in order to provide a means of monitoring element condition during operation. Filter units should be fitted with a sample line at the lowest point of the vessel to enable contaminants to be drained from the unit. The sample line should terminate with a ball valve and have a captive dust cap. Sample lines on filter units should be a minimum 13 mm (½") nominal bore but, in general, the larger the diameter of the sample line, the better. Where

practicable to do so, existing filter vessels/systems should be upgraded to meet the requirements of EI 1581 (latest edition) and JIG Aviation Fuel QC Bulletin No. 7.

- ii) **Fuel Monitor.** A fuel monitor should be fitted with an automatic air eliminator and be sized to suit the discharge rate and pressure of the delivery system. The elements should be EI 1583 approved and be designed to absorb any water still present in the fuel and to cut off the flow of fuel if the amount of water in the fuel exceeds an acceptable limit compromising fuel quality. The monitor is described as an Aviation Fuel Filter Monitor with absorbent type elements. A differential pressure gauge with calibrated reading should be fitted in order to provide a means of monitoring element condition during operation. Filter units should be fitted with a sample line at the lowest point of the vessel to enable contaminants to be drained from the unit. The sample line should terminate with a ball valve and have a captive dust cap. Sample lines on filter units should be a minimum 13 mm (½") nominal bore but, in general, the larger the diameter of the sample line, the better.
- iii) **Combined Three-Stage Filter Vessel.** Combined three-stage filter vessels should incorporate first-stage coalescer elements, second-stage separator elements and third-stage monitor elements within a single vessel and should be sited adjacent to or within the dispensing cabinet. Vessels should be fitted with an automatic air eliminator and pressure relief valve and sized to suit the discharge rate and pressure of the delivery system. Units should be EI 1581 approved (to the latest edition with reference to JIG Aviation Fuel QC Bulletin No. 7) and such filters should provide protection down to 1 micron particle size or better. Third-stage monitor elements should be EI 1583 approved and be designed to absorb any water still present in the fuel and to cut off the flow of fuel if the amount of water in the fuel exceeds an acceptable limit compromising fuel quality. Dual differential pressure gauges with calibrated reading should be fitted in order to provide a means of monitoring element condition during operation. One gauge should be set up to measure first-stage element condition with the other set up to measure third-stage element condition. The differential pressure generated across the second-stage element is insignificant and can therefore be measured combined with either first-stage or third-stage, depending on the vessel design. Filter units should be fitted with a sample line at the lowest point of the vessel to enable contaminants to be drained from the unit. The sample line should terminate with a ball valve and have a captive dust cap. Sample lines on filter units should be a minimum 13 mm (½") nominal bore but, in general, the larger the diameter of the sample line, the better.
- e) **Delivery Hose.** The delivery hose should be an approved semi-conducting type to ISO 1825:2011 type C, Grade 2, 38 mm (1½") internal bore fitted with reusable safety clamp adaptors; hoses of larger diameter may be required if a higher flow rate is specified. The hose should be stored on a reel suitable for the length and diameter of the hose being used (the minimum bend radius of the hose should be considered). The selected length of refuelling hose provided should be consistent with easily reaching the helicopter refuelling points when the aircraft is correctly positioned on the helideck.
- f) **Bonding Cable.** Where it is not practicable to fit an aircraft bonding safety system to existing refuelling systems as detailed in paragraph 3.6.1(b), a suitable high visibility bonding cable should be provided to earth the helicopter airframe before any fuelling commences. The cable should be earth-bonded, common to the system pipework at one end, and be fitted with a correct earthing adaptor to attach

to the aircraft at the aircraft end. In the event that a helicopter has to lift off quickly, a quick-release mechanism should be provided by fitting a 'breakaway device' into the bonding cable, a short distance away from the clamp at the helicopter end. The electrical resistance between the end connection and the system pipework should not be more than 0.5 ohms. The selected length of bonding cable provided should be consistent with easily reaching the helicopter refuelling points when the aircraft is correctly positioned on the helideck.

- g) **Fuelling Nozzle.** Fuel delivery to the aircraft may be either by gravity (overwing) or pressure (underwing) refuelling. It is operationally advantageous to have the ability to refuel by either means to suit the aircraft type using the helideck:
- i) **Gravity** – The nozzle should be 38 mm (1½”) spout diameter fitted with 100 mesh strainer. Suitable types include the EMCO G180-GRTB refuelling nozzle.
  - ii) **Pressure** – For pressure refuelling the coupling should be 63.5 mm (2½”) with 100 mesh strainer and quick disconnect. A Carter or Avery Hardoll pressure nozzle with regulator/surge control (maximum 241.3 kPa (35 psi)) should be used.
  - iii) **Pressure Gravity** – To meet both requirements, a pressure nozzle can be fitted to the hose end. A separate short length of hose fitted with an adaptor (to fit the pressure nozzle) and with the gravity nozzle attached can be used as required. This arrangement gives the flexibility to provide direct pressure refuelling or, with the extension hose attached, a means of providing gravity refuelling. Alternatively a GTP coupler may be used.
- h) **Weather Protection.** The delivery system, including hoses and nozzles, should be equipped with adequate weather protection to prevent deterioration of hoses and ingress of dust and water into the nozzles.

INTENTIONALLY LEFT BLANK

# Chapter 8 Helicopter Fuelling Facilities – Maintenance and Fuelling Procedures

## 1 General

- 1.1 This chapter gives general advice and best practice on the necessary requirements for fuelling system maintenance and the fuelling of helicopters on offshore installations and vessels. It includes recommended procedures for the filling of transit tanks, the transfer of fuel from transit tanks to static storage and the refuelling of aircraft from static storage.
- 1.2 Fuel storage, handling and quality control are key elements for ensuring, at all times, the safety of aircraft in flight. For this reason, personnel assigned supervisory and operating responsibilities should be certified as properly trained and competent to undertake systems maintenance, inspection and fuelling of aircraft.
- 1.3 The information in this chapter has been prepared by OGUK to be consistent with the relevant content of CAP 748 'Aircraft Fuelling and Fuel Installation Management', and in consultation with the offshore oil and gas industry and aviation specialists. If required, supplementary information may be obtained from CAP 748 and the specialist aviation fuel suppliers. The reader should ensure when referring to the best practice standards given in the text that they are current and embody the latest amendments.
- 1.4 Alternative procedures from other recognised national sources may be used where users can satisfy themselves that the alternative is adequate for the purpose, and achieves equivalence, considering particularly the hostile conditions to which the systems may be subjected and the vital and overriding importance of a supply of clean fuel.

**NOTE:** Certain companies arrange two-day training courses at onshore locations. The courses are intended for offshore staff who are involved with maintaining and operating helicopter fuel systems offshore. Details of courses may be obtained from Cogent OPITO on +44 (0) 1224 787800.

## 2 Fuel Quality Sampling and Sample Retention

- 2.1 Throughout the critical processes of aviation fuel system maintenance and fuelling operations, routine fuel sampling is required to ensure that delivered fuel is scrupulously clean and free from any contamination that may enter the aircraft fuel tanks which could ultimately result in engine malfunctions. The requirement to distinguish between colours during fuel sample testing (e.g. water detector tests) should be taken into account when selecting personnel for this task. The condition of colour blindness could potentially cause erroneous results.
- 2.2 **Fuel Sample Containers**
- 2.2.1 Fuel samples drawn from transit/static storage tanks and the fuel delivery system during daily and weekly tests should be retained in appropriate containers for specified periods. The sample containers should be kept locked in a secure, suitably constructed light-excluding store and kept away from sunlight until they are disposed of (aviation fuel is affected by UV light).

- 2.2.2 Only scrupulously clean, standard four-litre clear glass sampling jars should be used for taking fuel samples. It is strongly recommended that they are also used for initial storage. Supplementary items such as buckets and funnels, fitted with earth cable and clamp, should ideally be manufactured from stainless steel and, to prevent sample contamination, they should be scrupulously cleaned before each use.
- 2.2.3 It is recommended that the fuel samples are no longer kept in five-litre International Air Transport Association (IATA) lacquer-lined sample cans because their design prevents scrupulous cleaning and visual confirmation of removal of all sources of contamination (e.g. trace sediments) prior to re-use. Sediments trapped in IATA cans can result in highly inaccurate representations of drawn fuel samples when submitted for laboratory analysis, in the event of an aircraft incident where fuel is a suspected causal factor.
- 2.2.4 When drawn fuel samples are requested as evidence for analysis, the appropriate samples should be decanted from glass sample jars into unused, purpose-made IATA sample cans for transportation.

### 2.3 Fuel Sampling

- 2.3.1 Fuel samples taken from any aviation fuelling system should be the correct colour, clear, bright and free from solid matter. They should also be checked for dissolved water by using a syringe and water detection capsule.
- 2.3.2 Filter vessel and hose end samples should be taken under pump pressure.
- 2.3.3 Checking for fuel quality should be carried out whilst making observations in the following manner:
- a) Samples should be drawn at full flush into scrupulously clean, clear glass sample jars (four litre capacity).
  - b) The fuel should be of the correct colour, visually clear, bright and free from solid matter and free and dissolved water. (Jet A-1 may vary from colourless to straw colour.)
  - c) Free water will appear as droplets on the sides, or bulk water on the bottom, of the sample jar.
  - d) Suspended water will appear as a cloud or haze.
  - e) Solid matter is usually made up of small amounts of dust, rust, scale etc. suspended in the fuel or settled out on the jar bottom. When testing for dirt, swirl the sample to form a vortex, any dirt present will concentrate at the centre of the vortex making it more readily visible.
  - f) Testing for dissolved water should be done with a syringe and proprietary water detector capsule (e.g. Shell type or an approved alternative). Fit a capsule to the syringe, immerse in fuel and immediately draw a 5 ml fuel sample into the syringe. If the capsule is withdrawn from the fuel and there is less than 5 ml in the syringe, the capsule should be discarded and the test repeated using a new capsule. Examine the capsule for any colour change. If there is any colour change the fuel should be rejected.

Capsules should be kept tightly sealed in their container when not in use. Capsule tubes are marked with the relevant expiry date and capsules should be used before the end of the month shown on the container. Capsules should not be re-used.

**NOTE:** The use of water-finding paper or paste is no longer recommended. These methods do not meet the minimum standards for detecting water content at the fuel delivery point of 300 ppm (see IATA Guidance Material for Aviation Fuel Specifications).

## 2.4 Fuel Sample Retention

2.4.1 The purpose of retaining selected fuel samples during the handling processes is to provide proof of fuel quality when delivered to an aircraft.

2.4.2 In the event of an aircraft incident where fuel may be considered to be a causal factor retained fuel samples will subsequently be requested by the helicopter operator to support technical investigations.

2.4.3 The following table summarises the minimum recommended fuel sampling and retention requirements for offshore helicopter operations.

No.	Sample	Reason for Sampling and When Taken	Sample Retention Period
1	Transit tanks.	Filling onshore.	Until transit tank is returned onshore.
2	Transit tanks.	Within 24 hours of placement in a banded storage area and weekly thereafter until tank becomes next on-line.	24 hours.
3	Transfer filters.	Prior to fuel transfer or weekly, whichever occurs first.	When a satisfactory result has been obtained, samples can be discarded.
4	Transit tanks.	Prior to decanting to bulk storage tank or daily when on-line or next in-line.	24 hours.
5	Static storage tank.	Daily - prior to system use.	48 hours.
6	Delivery filter separator and filter monitor.	Daily - prior to system use.	When a satisfactory result has been obtained, samples can be discarded.
7	Delivery hose end.	Daily - prior to system use.	When a satisfactory result has been obtained, samples can be discarded.
8	Delivery hose end (or filter monitor if a pressure refuel is being performed).	Before aircraft refuelling. This sample to be checked by the pilot.	When a satisfactory result has been obtained and the flight crew have seen the evidence, samples can be discarded.
9	Delivery hose end (or filter monitor if a pressure refuel is being performed).	After aircraft refuelling.	24 hours. However, if the same aircraft is refuelled again on the same day, the previous sample may be discarded and the new one retained.
10	Tanks and delivery system.	After heavy rainfall or storms and if subject to water/foam deluge due to activation of the on-board fire protection system.	When taken, these samples replace the ones taken for 4 and 5 above.

## 2.5 Decanting from Sample Reclaim Tanks

- 2.5.1 Before transfer of fuel takes place from a sample reclaim tank to bulk storage, the reclaim tank should be sampled to ensure the fuel is in good condition.
- 2.5.2 Any samples taken prior to transfer should not be returned until transfer from the sample reclaim tank to the bulk tank has been completed, because this could stir up contaminants on the bottom of the vessel. After each transfer, the residue in the bottom of the vessel should be fully drained and the recovery tank cleaned.
- 2.5.3 The transfer water separator should also be sampled under pump pressure before the storage tank inlet valve is opened, to ensure that no contamination is present in the filter vessel. Any contaminated samples should be disposed of in a suitable container.

## 3 Recommended Maintenance Schedules

- 3.1 Different elements and components of the helicopter fuelling systems require maintenance at different times, ranging from daily checks of the delivery system to annual/biennial checks on static storage tanks.
- 3.2 Particularly in the UK, responsible bodies within the offshore oil and gas and aviation industries have developed maintenance regimes and inspection cycles to suit their specific operations. There may therefore appear to be anomalies between different source guidance on filter element replacement periodicity, hose inspection and replacement periodicity, static storage tank inspection periodicity and bonding lead continuity checks.
- 3.3 The various components of fuelling systems are listed with their recommended servicing requirements in the following paragraphs and tables.

### 3.4 Transit Tanks

- 3.4.1 All transit tanks should be subject to a 'trip examination' each time the tank is filled and, in addition, their condition should be checked weekly. Six-monthly and 12-monthly inspections should be carried out on all lined carbon steel tanks. However, for stainless steel tanks, the inspections can be combined at 12-monthly intervals.

#### a) Trip Inspection

Each time a transit tank is offered for refilling the following items should be checked:

No.	Items	Activity
i)	Tank Shell	Visual check for condition. Has the shell suffered any damage since its previous filling?
ii)	Filling/discharge and sampling points	Visual check for condition, leakage and caps in place.
iii)	Lifting lugs and four-point sling	Visual check for signs of damage.
iv)	Tank top fittings	Check for condition, caps in place, dirt free and watertight.
v)	Tank identification	Check that serial number and contents-identifying label are properly displayed.
vi)	Tank certificate	Ensure valid and located in the document container. (See paragraph 10.)



**b) Weekly Inspection**

Each transit tank whether it is full or empty, onshore or offshore, should be given a weekly inspection similar to the trip inspection at paragraph 3.4.1(a) to ensure that the tank remains serviceable and fit for purpose. The weekly inspection should primarily be for damage and leakage. The completion of this check should be signed for on the Serviceability Report (see paragraph 10).

**c) Six-Monthly Inspection**

The six-monthly inspection should be carried out onshore by a specialist organisation. This inspection should include:

No.	Items	Activity
i)	Tank identification plate	Check details.
ii)	Tank shell	Visual check for damage.
iii)	Paint condition (external)	Check for deterioration.
iv)	Paint condition (internal)	Check for deterioration, particularly if applicable around seams.
v)	Lining materials (if applicable)	Check for deterioration, lifting, etc. Methyl Ethyl Ketone (MEK) and/or acetone test should be carried out on linings or on any lining repairs.
vi)	Tank fittings (internal)	Check condition.
vii)	Tank fittings (external)	Check condition.
viii)	Access manhole	Check security.
ix)	Pressure relief valve	Check condition, in particular check for leaks.
x)	Dipstick assembly	Check constraint, markings and cover/cap for security.
xi)	Bursting disc	Check for integrity and cover/cap for security.
xii)	Inspection hatch assembly	Check seal condition and security.
xiii)	Bonding	Measure electrical bonding resistance between transit tank and its shell.
xiv)	General	Examination and test procedures to conform with current rules and industry standards.

**d) Re-certification**

It is a legal requirement that "single product" transit tanks are re-certified at least every five years by an authorised Fuel Inspector functioning under an approved verification scheme. There should also be an intermediate check carried out every 2½ years. These checks should also include re-certification of the pressure/vacuum relief valve. The date of the re-certification should be stamped on the tank inspection plate.

### 3.5 Static Storage Tanks

- 3.5.1 Static storage tanks are subject to an annual or biennial inspection depending on the type of tank. If the storage tank is mild steel with a lining then it should be inspected at least once per year. If the tank is stainless steel then a two-year interval between inspections is acceptable.
- 3.5.2 When due for inspection the tank should be drained and vented with the manhole access cover removed.
- 3.5.3 The inspection should include the following:

No.	Items	Activity
i)	Cleanliness	Clean tank bottom as required.
ii)	Tank internal fittings	Check condition.
iii)	Lining material (if applicable)	Acetone test (note this check need only be carried out on new or repaired linings).
iv)	Paint condition	Check for deterioration, particularly around seams.
v)	Access to tank top fittings	Check condition of access ladder/platform.
vi)	Inspection hatch	Check condition of seal.
vii)	Access manhole cover	Check seal for condition and refit cover securely. Refill tank.
viii)	Pressure relief valve	Check condition and certification, in particular check for leaks.
ix)	Floating suction	Check condition, continuity of bonding and operation.
x)	Valves	Check condition, operation and material.
xi)	Sump/drain line	Check condition, operation and material.
xii)	Grade identification	Ensure regulation Jet A-1 markings applied and clearly visible.
xiii)	Contents gauge	Check condition and operation.
xiv)	Bonding	Measure electrical bonding resistance between tank and system pipework.

### 3.6 Delivery Systems

- 3.6.1 The offshore delivery system should normally be inspected by the helicopter operator every three months. However, the inspection may be carried out by a specialist fuelling contractor on behalf of the helicopter operator. No system should exceed four months between successive inspections. In addition the system should be subject to daily and weekly checks by offshore fuelling personnel to ensure satisfactory fuel quality.

### a) Daily Checks

The following checks should be carried out each day.

No.	Items	Activity
i)	Microfilter and/or filter/ water separator and filter monitor	Drain the fuel from the sump until it is clear. The sample taken should be checked and retained as noted in paragraphs 2.3 and 2.4. <b>NOTE:</b> This check excludes the transfer filter which should be checked weekly or prior to use, whichever is the sooner. This can only be done when fuel is being transferred.
ii)	Transit tank/storage tank	A fuel sample should be drawn from each compartment of the transit tank/storage tank (as applicable) and checked for quality as noted in paragraphs 2.3 and 2.4.
iii)	Floating suction	The assembly should be checked for buoyancy and freedom of movement.
iv)	Delivery hose end	A sample should be drawn from the hose end and checked for quality as noted in paragraphs 2.3 and 2.4.
v)	Complete documentation	Daily checks should be recorded on the 'Daily Storage Check' pro forma.

### b) Weekly Checks

In addition to the daily checks specified in paragraph 3.6.1(a) the following checks should be carried out each week.

No.	Items	Activity
i)	Differential pressure gauge	Under full flow conditions during refuelling the differential pressure gauge reading should be noted and recorded on the filter record sheets.
ii)	Entire system	The system should be checked for leaks and general appearance including the transit tank checks detailed in paragraph 3.4.1(b).
iii)	Tank top fittings	Should be checked to see all are in place, clean and watertight.
iv)	Inlet and outlet couplings	Check caps are in place.
v)	Hose end strainers	Strainers fitted to fuelling nozzles and fuelling couplings should be inspected and cleaned. If significant quantities of dirt are found, the reason should be established and remedial action taken. During these checks the condition of any seal should be inspected for serviceability and to ensure they are correctly located/seated.

(continued)

No.	Items	Activity
vi)	Aviation delivery hose	The hose should be checked visually whilst subjected to system pump pressure. This particular check should be recorded on the hose inspection record.
vii)	Delivery nozzle/coupling	The delivery nozzle/coupling should be checked for condition and serviceability. The bonding wire and clip should also be checked for general condition, security and electrical continuity. Maximum 0.5 ohms.
viii)	Bonding Reel	Check for general condition, security and electrical continuity. Maximum 0.5 ohms. Check proper operation of quick release connection.
ix)	Documentation	Completion of these checks should be recorded on the serviceability report.

### c) Three-Monthly Inspection

A three-monthly check is the major inspection of the system. The following checklist of items to be included will depend on the particular installation and is included as a general guide only. Additional items may be included when considered appropriate.

No.	Items	Activity
i)	All filtration units (e.g. decant line, dispenser and monitor filter)	Obtain a fuel sample from each filtration unit and perform fuel quality checks as noted in paragraphs 2.3 and 2.4. Note results of the sample checks on system records. If consistently bad samples are evident on the three-monthly check it could indicate the presence of bacteriological growth in the separator. This will require the following action to be taken: Open the filter vessel and inspect for surfactants, bacteriological presence, mechanical damage and condition of lining (if applicable). Clean out any sediment and carry out a water test on the water separator element.
ii)	Earth bonding check	Carry out a continuity test throughout the system.
iii)	Suction fuel hose and coupling	Carry out the following inspections: a) Check condition of outer protective cover if fitted. b) Check hose for damage and leakage. c) Check end connections for damage and leakage. d) Check correct operation of hose coupling. e) Check end cap present.

(continued)

No.	Items	Activity
iv)	Pump unit	Remove, clean and inspect strainers. If air driven, then remove air line lubricator, regulator and water separator units and service as required.
v)	Hose reel	Ensure reel mechanism operates correctly and grease rewind gears.
vi)	Differential pressure gauge	Check for correct operation and, if the differential pressure limit is exceeded, renew filter element.
vii)	Automatic air eliminator	Prime and check for correct operation of the unit. If a manual unit is fitted, replace with an automatic type.
viii)	Delivery hose	Carry out a visual check over the ENTIRE length of the hose whilst under system pressure. Look for external damage, soft areas, blistering, bulging, leakage and any other signs of weakness. Particular attention should be paid to those sections of the hose within approximately 45 cm (18") of couplings since these sections are especially prone to deterioration.
ix)	Delivery coupling/nozzle	Carry out the following inspections and tests: a) Check operation to ensure correct lock off and no leakages. b) Remove, clean and visually check cone strainers, replace as necessary. c) Check earth bonding wire assemblies and bonding clips and pins. Renew if required. d) Ensure all dust caps are present and are secured. <b>NOTE:</b> No lubrication except petroleum jelly should be applied to any of the coupling or nozzle parts.
x)	Main earth bonding	Carry out the following inspections and tests: a) Check for correct operation of the rewind mechanism. Adjust and lubricate as necessary. b) Carry out a visual check on earth bonding cable and terminal connections, replace if required. c) Check condition of earth clamp and quick disconnect assembly. d) Carry out continuity check. Maximum 0.5 ohms.
xi)	Documentation	Completion of this inspection should be recorded on the serviceability report.

#### d) Six-Monthly Inspection

Six-monthly checks should be carried out only by an authorised Fuel Inspector. The content of a six-monthly check should include all of the three-monthly checks detailed in paragraph 3.6.1(c) and, in addition, should include the following items:

No.	Items	Activity
i)	All filtration units (e.g. decant line, dispenser and monitor filter)	Carry out the following inspections to ensure: a) Units have the correct fuel grade identification. b) The connecting pipework has the correct fuel grade identification.
ii)	Electrical pump unit (if applicable)	Carry out the following inspections and tests: a) All electrical circuits to be checked by a qualified electrician. b) Check gearbox oil level is appropriate. c) Lubricate pump bearings. d) Check coupling between motor and pump for wear and signs of misalignment. e) Refer to pump manufacturer's recommended maintenance schedule for additional items.
iii)	Air-driven pump system (if applicable)	Carry out the following inspections and tests: a) Lubricate air motor bearings. b) Lubricate pump bearings. c) Check coupling between motor and pump for wear and signs of misalignment. d) Refer to pump manufacturer's recommended maintenance schedule for additional items.
iv)	Metering unit	Carry out the following inspections and tests: a) Check operation of automatic air eliminator. b) Lubricate the meter register head, drive and calibration gears with petroleum jelly only. c) Clean and inspect strainer element.
v)	Hose reel	Carry out the following inspections and tests: a) Check tension on chain drive and adjust if necessary. b) Lubricate the bearings.
vi)	Delivery hose	Ensure the correct couplings are attached to the hose.
vii)	Documentation	Completion of this inspection should be recorded on the serviceability report.

### e) Annual Inspection

Annual checks should be carried out by an authorised Fuel Inspector. The content of the annual check includes all the items in both the three-monthly and six-monthly inspections and the following additional items:

No.	Items	Activity
i)	All filtration units (e.g. transfer, water separator and monitor filters)	a) Remove and discard existing coalescer and monitor elements (see Note below). Clean out vessel. Visually check all areas of lining for signs of deterioration. b) Carry out water test on separator element if applicable. <b>NOTE:</b> For onshore installations, filter elements need only be replaced "on condition" or every three years. For offshore installations filter elements should be replaced either annually or, if appropriate, less frequently (e.g. three years) in accordance with the original equipment manufacturer's (OEM) instructions. c) Carry out MEK test if applicable. d) Carry out DfT thickness test on vessel interior linings if applicable (this is only necessary on new or repaired linings). e) Apply pin hole detection test if applicable. <b>NOTE:</b> These need only be carried out to check for correct curing when lining is new or has been repaired. f) Fit new elements. g) Fit new gasket and seals. h) Mark the filter body with the dates of the last filter element change date and the next due date.
ii)	Delivery hose	Ascertain when hose was fitted from system records. Delivery hose should be re-certified every two years or earlier if any defects are found which cannot be repaired. The hose will have a ten-year life from date of manufacture.
iii)	Fuel delivery meter	The meter should be calibrated in accordance with the manufacturer's recommendation.

## 4 Filling of Transit Tanks

4.1 The trip examination should be carried out as specified in paragraph 3.4.1(a). The tank should then be dipped to ascertain the quantity of fuel in the tank in order to calculate the volume of fuel required to fill the tank. The following items should then be completed:

- a) Draw fuel from transit tank sample line and discard until the samples appear free from water.
- b) Carry out fuel quality check as noted in paragraph 2.3.

- c) Once satisfied that the fuel is free from water, draw off sufficient fuel to measure its specific gravity with a clean hydrometer. The fuel temperature should also be noted in order to correct the measured specific gravity to a relative density (this is done using a correction graph).
- d) The relative density of the fuel sample taken from the transit tank should be compared with that of the previous recorded relative density after the last tank filling. The relative density of the previous batch of fuel should be taken from the previous release note or from the label from the retained sample. If the difference in relative densities exceeds 0.003 the contents of the transit tank may have been contaminated with some other product and the refilling should not take place.
- e) Connect the bonding wire to the transit tank then connect the delivery hose coupling to the transit tank filling point and start the transfer pump to fill the tank. When the meter register head indicates that the required quantity of fuel has been transferred, stop the transfer pump, remove the coupling from the tank and then remove the bonding connection. The dust cap should then be replaced on the filling point.
- f) Leave the tank to settle for ten minutes then a further sample should be drawn from the tank once it has been filled. This sample should be labelled with the tank number, the fuel batch number and date of filling and should then be retained safely until the tank is offered again for refilling. The sample should be subjected to a relative density check following the same process given in paragraph (c). The record of this should be within 0.003 of the composite relative density of the bulk tank contents and transit tank residue. This relative density reading should be recorded to allow the fuel remaining in the tank to be checked for possible contamination when the tank next returns from offshore for the next tank filling. This fuel sample will be required as a proof of fuel quality in the event of an aircraft incident where fuel may be considered to be a causal factor.
- g) The tank should then be sealed and a release note completed with all the required particulars; special attention should be paid that the correct grade of fuel is included on this release note.
- h) A copy of the release note should be secured in the tank document container and a further copy retained for reference.

## **5 Receipt of Transit Tanks Offshore**

- 5.1 Transit tanks transported offshore are often exposed to sea spray and harsh weather conditions on supply vessels and this could potentially cause ingress of water into the fuel. It is strongly recommended that fuel sampling is carried out as soon as the appropriate settling time has elapsed or at least within 24 hours of the tank being placed into a bunded storage area on the installation or vessel. Settling times are one hour per foot depth of fuel in the tank.
- 5.2 The following procedure should then be followed:
  - a) Check transit tank seals are still intact.
  - b) Check transit tank grade marked.
  - c) Check tank shell for damage, particularly around welded seams.
  - d) Check release note for the following:
    - i) correct grade;
    - ii) quantity;



- iii) batch number;
  - iv) date;
  - v) certified free from dirt and water; and
  - vi) signed by authorised product inspector.
- e) Take fuel samples from the transit tank and discard until the samples appear free from water.

## 6 Decanting from Transit Tanks to Static Storage

- 6.1 Before commencing any transfer of fuel it is necessary to dip the storage tank to ensure that the contents of the transit tank can be accommodated within the intended storage facility.
- 6.2 The transit tank should have had sufficient time to settle once positioned correctly for the transfer operation. Settling times are one hour per foot depth of fuel in the tank.
- 6.3 Bulk storage tanks equipped with a floating suction device need at least one hour for settling time and tanks without floating suction should be left for a period in hours approximately equal to the depth of fuel in feet (e.g. six feet depth of fuel should be left to settle for a period of at least six hours).
- 6.4 The following procedure should then be followed:
- a) Connect an earth bonding lead to the transit tank.
  - b) Carry out checks for fuel quality as described in paragraph 2.3.
  - c) If the transit tank sample test is not satisfactory, then draining a quantity of fuel off at full flush and then retesting may produce a satisfactory result.
  - d) Once a satisfactory test has been obtained the transfer hose should be connected to the transit tank discharge point (via a suitable filter, i.e. one micron or less). Open valve.
  - e) With the transfer pump running obtain a sample from the transfer filter vessel until a satisfactory result is obtained. Stop the pump.  
**NOTE:** Fuel should be pumped (not 'gravity' decanted) through filtration vessels for the elements to be effective.
  - f) Re-start the transfer pump and open the static tank inlet valve to start the fuel flow. Once fuel transfer has commenced check the coupling connections for any signs of leakage and continue to monitor the fuel flow whilst transfer is taking place.
  - g) When sufficient fuel has been transferred, shut off the valves and stop the transfer pump.
  - h) Disconnect the transfer hose followed by the electrical bonding lead and replace any dust caps that were removed at the commencement of the operation.
  - i) Record fuel quality checks and the transfer of the transit tank contents into the storage tanks and retain the release note on board the installation/vessel.
  - j) After transfer of fuel into the bulk storage tank and before it is released for use, ensure that the fuel is allowed to settle in accordance with the time periods set out above.

## **7 Fuelling Direct from Transit Tanks**

- 7.1 Many offshore helicopter fuelling systems are designed to supply aviation fuel direct from the transit tanks into the delivery system.
- 7.2 In this case the following procedure should be followed:
- a) Once the transit tank is correctly positioned for the fuel storage operation and before it is released for use, ensure that the fuel is allowed sufficient time to settle in accordance with the following time periods. Settling times are one hour per foot depth of fuel in the tank.
  - b) Connect an earth bonding lead to the transit tank.
  - c) Take fuel samples from the transit tank and discard until the samples appear free from water.
  - d) Carry out checks for fuel quality as described in paragraph 2.3.
  - e) If the transit tank sample test is not satisfactory, then draining a quantity of fuel off at full flush and then retesting may produce a satisfactory result.
  - f) Once a satisfactory test has been obtained the suction hose should be connected to the transit tank discharge point. Open valve.
  - g) With the delivery pump running obtain a sample from the delivery filter water separator, filter water monitor and hose end until a satisfactory result is obtained from each.
  - h) Record fuel quality checks and transit tank contents and retain the release note on board the installation/vessel.

## **8 Long Term Storage of Aviation Fuel**

- 8.1 The long term storage of aviation fuel offshore should be discouraged. Should fuel stocks remain unused offshore for an extended period (e.g. six months after the filling date) then, prior to use, samples should be drawn from the tank and sent onshore for laboratory testing to ensure fuel quality. An alternative course of action is to return the transit tank(s) to an onshore fuel depot for further action.

## **9 Aircraft Refuelling**

- 9.1 Always ensure before starting any refuelling that the fuel in the storage tank or transit tank is properly settled. Refer to paragraph 6 for correct settling times.
- 9.2 Before the commencement of any helicopter refuelling, the HLO should be notified. All passengers should normally be disembarked from the helicopter and should be clear of the helideck before refuelling commences (see also (i) below). The fire team should be in attendance at all times during any refuelling operation. The following procedure should then apply:
- a) When the aircraft captain is ready and it has been ascertained how much fuel is required and that the grade of fuel is correct for the particular aircraft, run out the earth bonding lead and attach it to the aircraft. Next, run out the delivery hose on the helideck to the aircraft refuelling point.
  - b) Take a fuel sample from the overwing nozzle or from the pressure refuelling coupling sample point and carry out a water detection check. For two-pilot operations, this water detection check should be witnessed by the non-handling

pilot, who should be satisfied that the fuel water test is acceptable. During single-pilot operations the water detection capsule should be shown to the pilot after the water detection check.

**NOTE:** Only if there is no pressure refuelling coupling sample point should a sample be drawn from the filter water monitor drain point.

- c) If pressure refuelling, first connect the secondary bonding lead to bond the refuelling nozzle to the aircraft, then connect the pressure coupling to the aircraft and remain adjacent to the fuelling point. If gravity refuelling, first connect the secondary bonding lead to bond the refuelling nozzle to the aircraft, then open the tank filler and insert the nozzle and prepare to operate the fuel lever when signalled to do so by the person in charge of refuelling.
- d) The nominated person in charge of the refuelling should operate the system pump switches and open any necessary valves to start the flow of fuel only when given clearance by the pilot via the HLO.
- e) If any abnormalities are observed during the refuelling the "off" switch should immediately be operated. When refuelling is complete, the pump should be shut down and the nozzle handle released.
- f) Remove the refuelling nozzle or disconnect the pressure coupling as appropriate and replace the aircraft filler and nozzle caps. Finally disconnect the secondary bonding lead. A further fuel sample should now be taken, witnessed by the pilot, as in (b) above and a fuel water check should again be carried out. See also paragraph 2.4 for sample retention requirements.
- g) Remove the delivery hose from the helideck and carry out a final check that the aircraft filler cap is secure, then disconnect the main bonding lead from the aircraft and check that all equipment is clear from the proximity of the aircraft. The hose should be rewound onto its reel.
- h) Enter the fuel quantity onto the daily refuelling sheet and obtain the pilot's signature for the fuel received.
- i) If for safety reasons the aircraft captain has decided that the refuelling should be carried out with engines and/or rotors running and/or with passengers embarked, the following additional precautions should be undertaken:
  - i) Constant communications should be maintained between the aircraft captain and the refuelling crew.
  - ii) The passengers should be briefed.
  - iii) The emergency exits opposite the refuelling point should be unobstructed and ready for use (and remain open, weather permitting). Doors on the refuelling side of the helicopter should remain closed.
  - iv) Passengers' seatbelts should be undone.
  - v) At least one competent person should be positioned ready to supervise disembarkation in the event of an emergency.
  - vi) Provision should be made for safe and rapid evacuation as directed by competent persons. The area beneath the emergency exits should be kept clear.

**NOTE:** If the presence of fuel vapour is detected inside the helicopter, or any other hazard arises during refuelling, fuelling should be stopped immediately.

## 10 Quality Control Documentation

- 10.1 Recording of aviation refuelling system/component manufacture, routine maintenance and rectification, testing, fuel transfer history and aircraft refuelling, etc. should be completed on official company documentation. This documentation is normally provided by the helicopter operators and/or specialist fuel suppliers and system maintainers. As a minimum, the documentation used should comprise:
- Fuel Release Certificate (Note: Tank Certificate details should also be recorded on the Fuel Release Certificate);
  - record of transit tank receipt;
  - daily and weekly serviceability report;
  - daily storage checks;
  - differential pressure record;
  - hose inspection and nozzle filters test record;
  - storage tank checks before and after replenishment;
  - fuel system maintenance record;
  - tank inspection and cleaning record; and
  - fuelling daily log sheet.

# Chapter 9 Helicopter Landing Areas on Vessels

## 1 Vessels Supporting Offshore Mineral Workings and Specific Standards for Landing Areas on Merchant Vessels

- 1.1 Helidecks on vessels used in support of the offshore oil and gas industry should be designed to comply with the requirements of the preceding chapters of this publication.
- 1.2 The ICS has published a 'Guide to Helicopter/Ship Operations', updated in 2008, which comprehensively describes physical criteria and procedures on ships having shipboard heliport landing or winching area arrangements. Other than to address the basic design criteria and marking and lighting schemes related to shipboard heliport landing area arrangements, it is not intended to reproduce detail from the ICS document here in CAP 437. However, it is recommended that the 2008 4th edition of the ICS 'Guide' should be referenced in addition to this chapter and, where necessary, in conjunction with Chapter 10 which includes information relating to shipboard heliport winching area arrangements.
- 1.3 Helicopter landing areas on vessels which comply with the criteria and which have been satisfactorily assessed will be included in the HLL. This list will specify the D-value of the helicopter landing area; include pitch and roll, SHR and helideck inclination category information with helicopter operator derived landing limits; list any areas of non-compliance against CAP 437; and detail any specific limitations applied to the landing area. Vessels having ships'-side or amidships purpose-built or non-purpose-built landing areas may be subject to specific limitations.
- 1.4 Helicopter landing areas on vessels should always have an approved D-value equal to or greater than the 'D' dimension of the helicopter intending to land on it.
- 1.5 Helicopter landing areas which cannot be positioned so as to provide a full 210° obstacle-free sector surface for landing and take-off will be assessed against specific criteria described in this chapter and appropriate limitations will be imposed.
- 1.6 It should be noted that helicopter operations to small vessels with poor visual cues, such as bow decks or a deck mounted above the bridge superstructure with the landing direction facing forwards (bow deck) or abeam (high deck), will have stricter landing limits imposed at night, with respect to the vessel's movement in pitch and roll, SHR and helideck inclination.

## 2 Amidships Helicopter Landing Areas – Purpose-Built or Non-Purpose-Built Ship's Centreline

### 2.1 General

- 2.1.1 The following special requirements apply to vessels which can only accommodate a helicopter landing area in an obstructed environment amidships. The centre of the landing area will usually be co-located on the centreline of the vessel, but may be offset from the ship's centreline either to the port or starboard side up to the extent that the edge of the landing area is coincidental with the ship's side.

### 2.2 Size and Obstacle Environment

- 2.2.1 The reference value D (overall dimension of helicopter) given at Table 1 (Chapter 3) also applies to vessels' landing areas referred to in this Chapter. It should also be noted that amidships landing areas are only considered suitable for single main rotor helicopters.

- 2.2.2 Forward and aft of the minimum 1D landing area should be two symmetrically located 150° LOS with apexes on the circumference of the 'D' reference circle. Within the area enclosing these two sectors, and to provide 'funnel of approach protection' over the whole of the D-circle, there should be no obstructions above the level of the landing area except those referred to in Chapter 3, paragraph 6.2 which are permitted up to a maximum height of 25 cm above the landing area level for any shipboard heliport where the D-value is greater than 16.00 m or 5 cm above the landing area level for any shipboard heliport where the D-value is 16.00 m or less.
- 2.2.3 On the surface of the landing area itself, objects whose function requires them to be located there, such as deck-mounted lighting systems (see Chapter 4, paragraph 3 and Appendix C) and landing area nets (see Chapter 3, paragraph 7.3), should not exceed a height of 25 mm.
- 2.2.4 To provide protection from obstructions adjacent to the landing area, an obstacle protection surface should extend both forward and aft of the landing area. This surface should extend at a gradient of 1:5 out to a distance of D as shown in Figure 1.
- 2.2.5 Where the requirements for the LOS cannot be fully met but the landing area size is acceptable, it may be possible to apply specific operational limitations or restrictions which will enable helicopters up to a maximum D-value of the landing area to operate to the deck.
- 2.2.6 The structural requirements referred to in Chapter 3 should be applied whether providing a purpose-built amidships shipboard heliport above a ship's deck or providing a non-purpose-built landing area arrangement utilising part of the ship's structure, e.g. a large hatch cover.

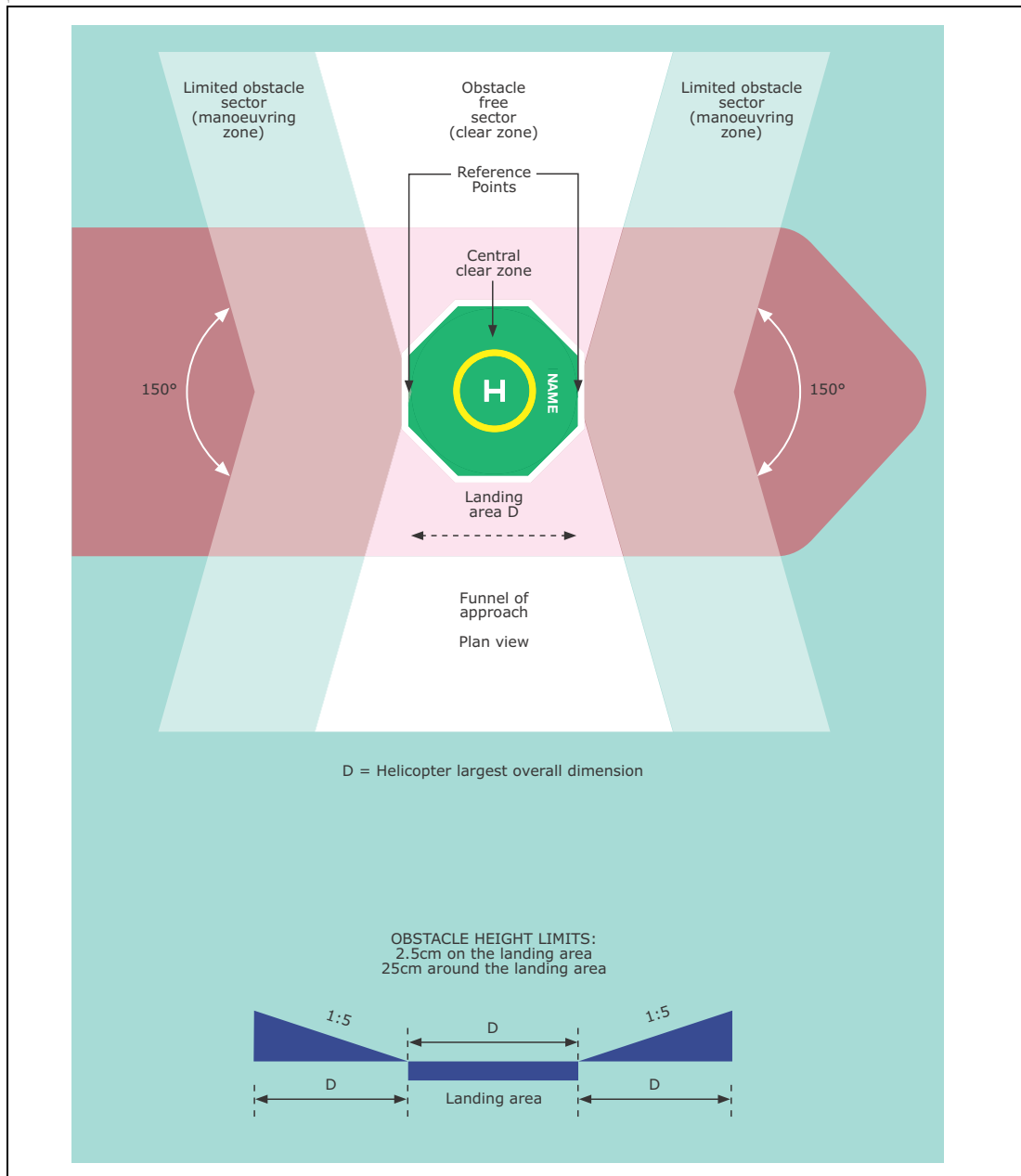

**Figure 1** A Purpose-Built or Non-Purpose-Built Midship Centreline Landing Area<sup>1</sup>

**Note:** Where the D-value is 16.00 m or less the obstacle height limitation around the landing area is restricted to 5 cm.

### 3 Helicopter Landing Area Marking and Lighting

- 3.1 The basic marking and lighting requirements referred to at Chapter 4 and Appendix C will also apply to helicopter landing areas on ships ensuring that for amidships helicopter landing areas the TD/PM Circle should always be positioned in the centre of the landing area and both the forward and aft 'origins' denoting the LOS should be marked with a black chevron (see Chapter 4, Figure 2). In addition, where there is an operational requirement, vessel owners may consider providing the helideck name marking and maximum allowable mass 't' marking both forward *and* aft of the painted helideck identification 'H' marking and TD/PM Circle.

1. Figure courtesy of International Chamber of Shipping, Helicopter Ship Guide (2008).

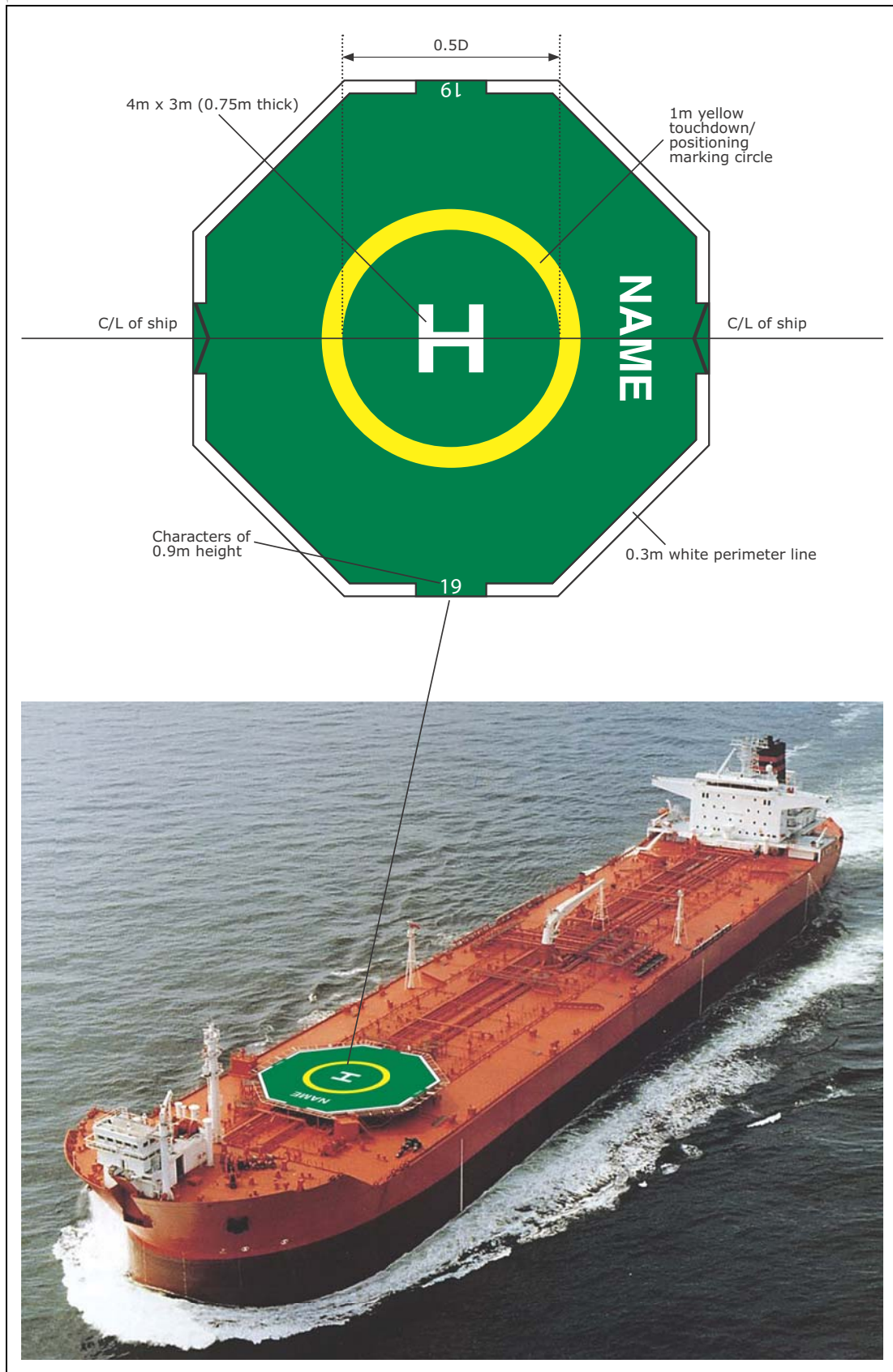

**Figure 2** Markings for a Purpose-Built or Non-Purpose-Built Midship Centreline Landing Area<sup>1</sup>

1. Original figure courtesy of International Chamber of Shipping, Helicopter Ship Guide (2008).



## 4 Ship's Side Non-Purpose-Built Landing Area

- 4.1 A non-purpose-built landing area located on a ship's side should consist of a clear zone and a manoeuvring zone as shown in Figure 3. The clear zone should be capable of containing a circle with a minimum diameter of  $1 \times D$ . No objects should be located within the clear zone except aids whose presence is essential for the safe operation of the helicopter, and then only up to a maximum height of 2.5 cm. Such objects should only be present if they do not represent a hazard to helicopters. Where there are immovable fixed objects located in the clear zone, such as a Butterworth lid, these should be marked conspicuously and annotated on the ship's operating area diagram (a system of annotation is described in detail in Appendix F to the ICS Helicopter Ship Guide). In addition, a manoeuvring zone should be established, where possible, on the main deck of the ship. The manoeuvring zone, intended to provide the helicopter with an additional degree of protection to account for rotor overhang beyond the clear zone, should extend beyond the clear zone by a minimum of  $0.25D$ . The manoeuvring zone should only contain obstacles whose presence is essential for the safe operation of the helicopter, and up to a maximum height of 25 cm. Where the D-circle accommodated is 16.00 m or less, obstacles contained in the manoeuvring zone should not exceed a height of 5 cm.

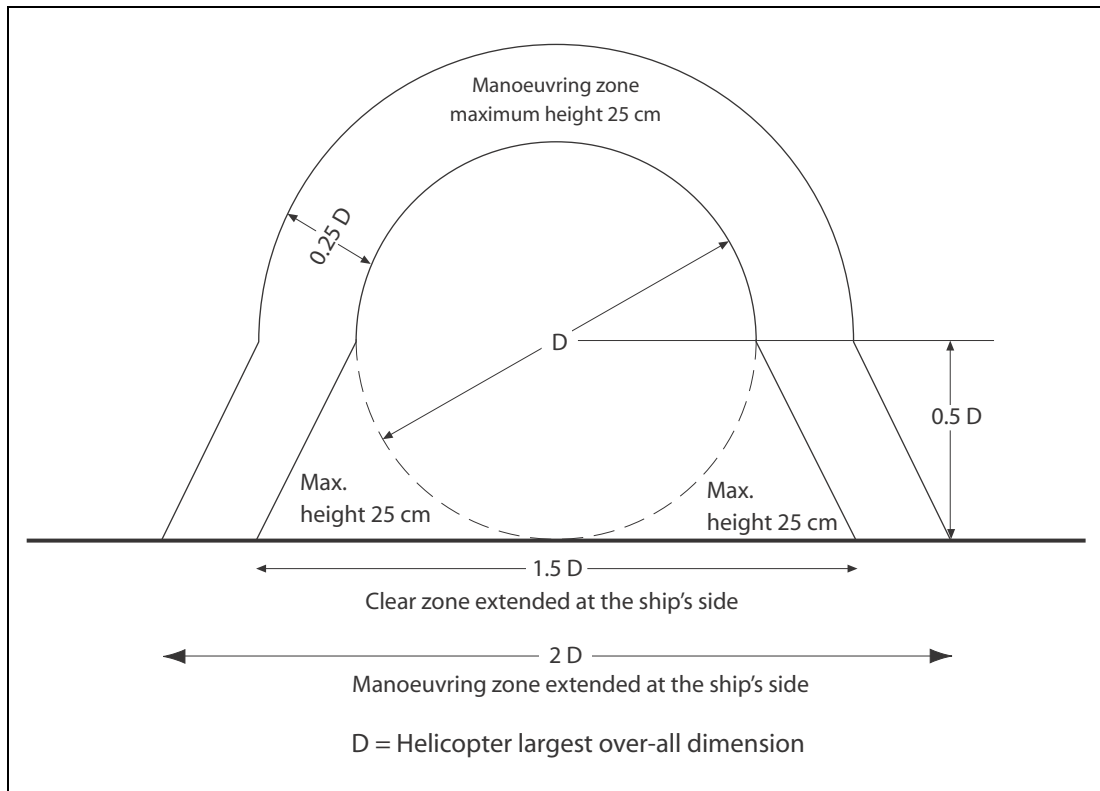

**Figure 3** Ship's Side: Non-Purpose-Built Landing Area

- 4.2 Where the operating area is coincident with the ship's side, and in order to improve operational safety, the clear zone should extend to a distance of  $1.5D$  at the ship's side while the manoeuvring zone should extend to a distance of  $2D$  measured at the ship's side. Within this area, the only obstacles present should be those essential for the safe operation of the helicopter, with a maximum height of 25 cm (or 5 cm where the D-circle accommodated has a diameter of 16.00 m or less). Where there are immovable fixed objects such as tank cleaning lines they should be marked conspicuously and annotated on the ship's operating area diagram (see Appendix F in the ICS Helicopter Ship Guide).

- 4.3 Any railings located on the ship's side should be removed or stowed horizontally along the entire length of the manoeuvring zone at the ship's side (i.e. over a distance of at least  $2D$ ). All aerials, awnings, stanchions and derricks and cranes within the vicinity of the manoeuvring zone should be either lowered or securely stowed. All dominant obstacles within, or adjacent to, the manoeuvring zone should be conspicuously marked and, for night operations, lit (see paragraph 6 and Chapter 4, paragraph 4).

## 5 Ship's Side Non-Purpose-Built Landing Area Markings

- 5.1 A TD/PM Circle, denoting the touchdown point for the helicopter, should be located centrally within the clear zone. The diameter of the clear zone should be  $1 \times D$  ( $D$  being the extent of the available operating area), while the inner diameter of the TD/PM should be  $0.5D$ . The TD/PM Circle should be at least 0.5 m in width and painted yellow. The area enclosed by the TD/PM Circle should be painted in a contrasting colour, preferably dark green. A white 'H' should be painted in the centre of the circle, with the cross bar of the 'H' running parallel to the ship's side. The 'H' marking should be 4 m high x 3 m wide, the width of the marking itself being 0.75 m.
- 5.2 The boundary of the clear zone, capable of enclosing a circle with a minimum diameter of  $1 \times D$  and extending to a total distance of  $1.5D$  at the ship's side, should be painted with a continuous 0.3 m wide yellow line. The actual  $D$ -value, expressed in metres rounded to the nearest whole number (with 0.5 m rounded down), should also be marked in three locations around the perimeter of the clear zone in a contrasting colour, preferably white. The height of the numbers so marked should be 0.9 m.
- 5.3 The boundary of the manoeuvring zone, located beyond the clear zone and extending to a total distance of  $2D$  at the ship's side, should be marked with a 0.3 m wide broken yellow line with a mark:space ratio of approximately 4:1. Where practical, the name of the ship should be painted in a contrasting colour (preferably white) on the inboard side of the manoeuvring zone in (minimum) 1.2 m high characters (see Figure 4).

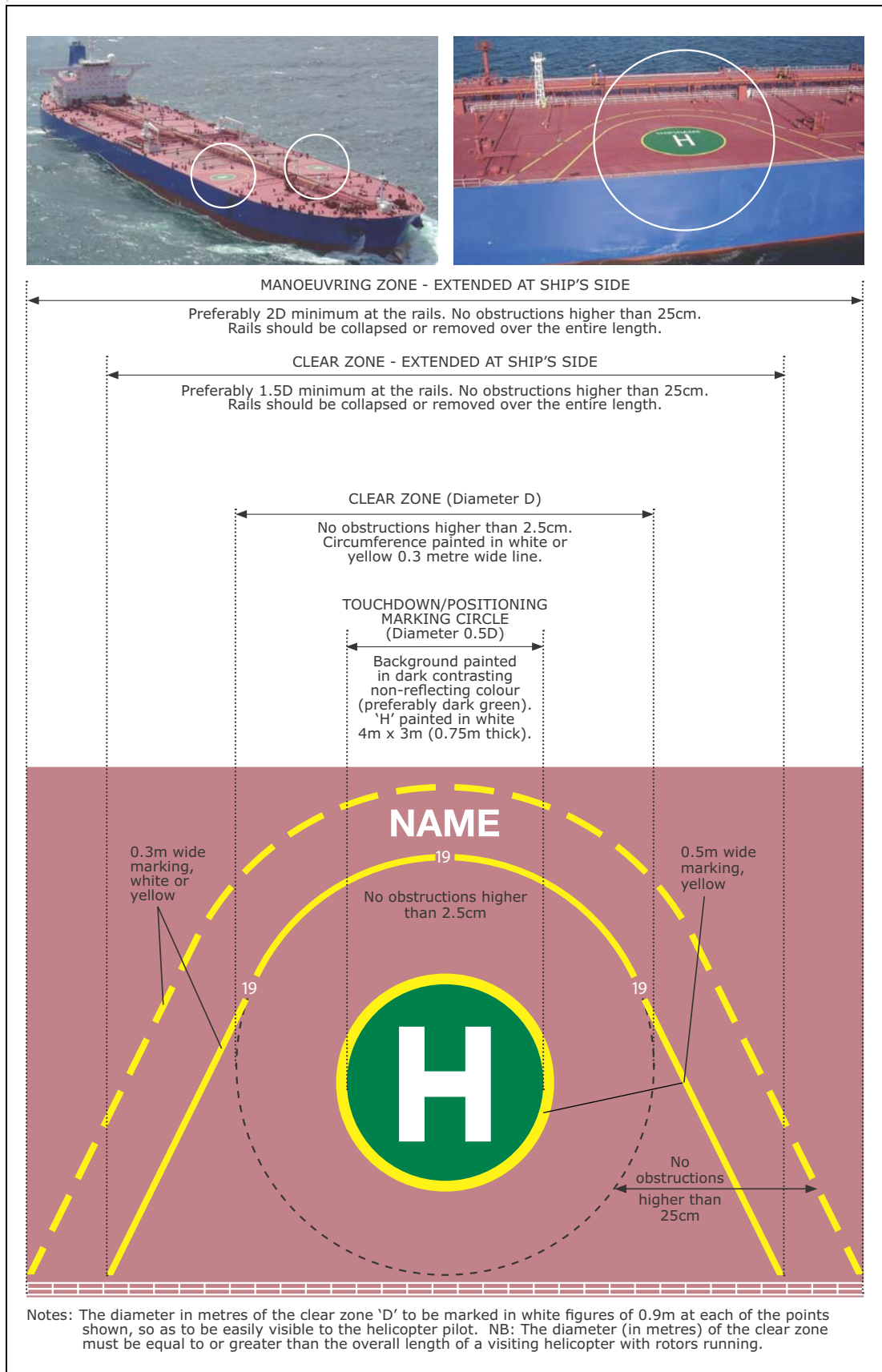
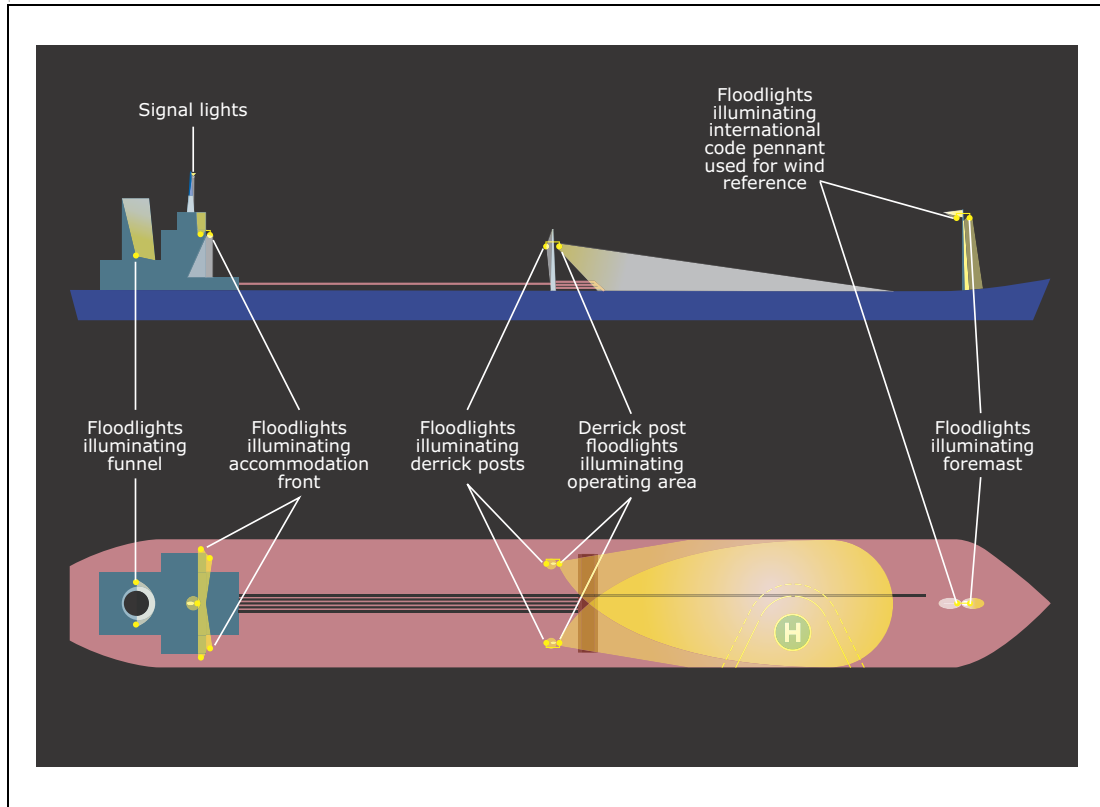

**Figure 4** Ship's Side Non-Purpose-Built Landing Area Markings<sup>1</sup>

1. Original figure courtesy of International Chamber of Shipping, Helicopter Ship Guide (2008).

## 6 Night Operations

- 6.1 Details of landing area lighting for purpose-built landing areas are given at Chapter 4 and Appendix C. In addition, Figure 5 shows an example of the overall lighting scheme for night helicopter operations (example shows a non-purpose-built ship's side arrangement).



**Figure 5** Representative Landing Area Lighting Scheme for a Non-Purpose-Built Ship's Side Arrangement<sup>1</sup>

## 7 Poop Deck Operations

- 7.1 Poop deck operations are addressed fully in the ICS Guide.

1. Figure courtesy of International Chamber of Shipping, Helicopter Ship Guide (2008).

# Chapter 10 Helicopter Winching Areas on Vessels and on Wind Turbine Platforms

## 1 Winching Areas on Vessels

1.1 Where practicable, the helicopter should always land rather than hoist, because safety is enhanced when the time spent hovering is reduced. In both cases the Vessel's Master should be fully aware of, and in agreement with, the helicopter pilot's intentions.

1.2 The ICS has published a 'Guide to Helicopter/Ship Operations', updated in 2008, which comprehensively describes physical criteria and procedures applicable for a shipboard winching area operation. It is not intended to reproduce the procedures from the ICS document in detail in this seventh edition of CAP 437 and therefore the ICS Guide may need to be referenced in addition to Chapter 10, paragraph 1.

### 1.3 Design and Obstacle Restriction

1.3.1 A winching area should be located over an area to which the helicopter can safely hover whilst hoisting to or from the vessel. Its location should allow the pilot an unimpeded view of the whole of the clear zone whilst facilitating an unobstructed view of the vessel. The winching area should be located so as to minimise aerodynamic and wave motion effects. The area should preferably be clear of accommodation spaces (see also paragraph 1.6) and provide adequate deck area adjacent to the manoeuvring zone to allow for safe access to the winching area from different directions. In selecting a winching area the desirability for keeping the hoisting height to a minimum should also be borne in mind.

1.3.2 A winching area should provide a manoeuvring zone with a minimum diameter of 2D (twice the overall dimension of the largest helicopter permitted to use the area). Within the manoeuvring zone a clear zone should be centred. This clear zone should be at least 5 m in diameter and should be a solid surface capable of accommodating personnel and/or stores during hoisting operations. It is accepted that a portion of the manoeuvring zone, outside the clear area, may be located beyond the ship's side but should nonetheless comply with obstruction requirements shown in Figure 1. In the inner portion of the manoeuvring zone no obstructions should be higher than 3 m. In the outer portion of the manoeuvring zone no obstructions should be higher than 6 m.

### 1.4 Visual Aids

1.4.1 Winching area markings should be located so that their centres coincide with the centre of the clear zone (see Figure 1).

1.4.2 The 5 m minimum diameter clear zone should be painted in a conspicuous colour, preferably yellow, using non-slip paint.

1.4.3 A winching area outer manoeuvring zone marking should consist of a broken circle with a minimum line width of 30 cm and a mark:space ratio of approximately 4:1. The marking should be painted in a conspicuous colour, preferably yellow. The extent of the inner manoeuvring zone may be indicated by painting a thin white line, typically 10 cm thickness.

1.4.4 Within the manoeuvring zone, in a location adjacent to the clear area, 'WINCH ONLY' should be easily visible to the pilot, painted in not less than 2 m characters, in a conspicuous colour.

- 1.4.5 Where hoisting operations to vessels are required at night, winching area floodlighting should be provided to illuminate the clear zone and manoeuvring zone areas. Floodlights should be arranged and adequately shielded so as to avoid glare to pilots operating in the hover.
- 1.4.6 The spectral distribution of winching area floodlights should be such that the surface and obstacle markings can be clearly identified. The floodlighting arrangement should ensure that shadows are kept to a minimum.

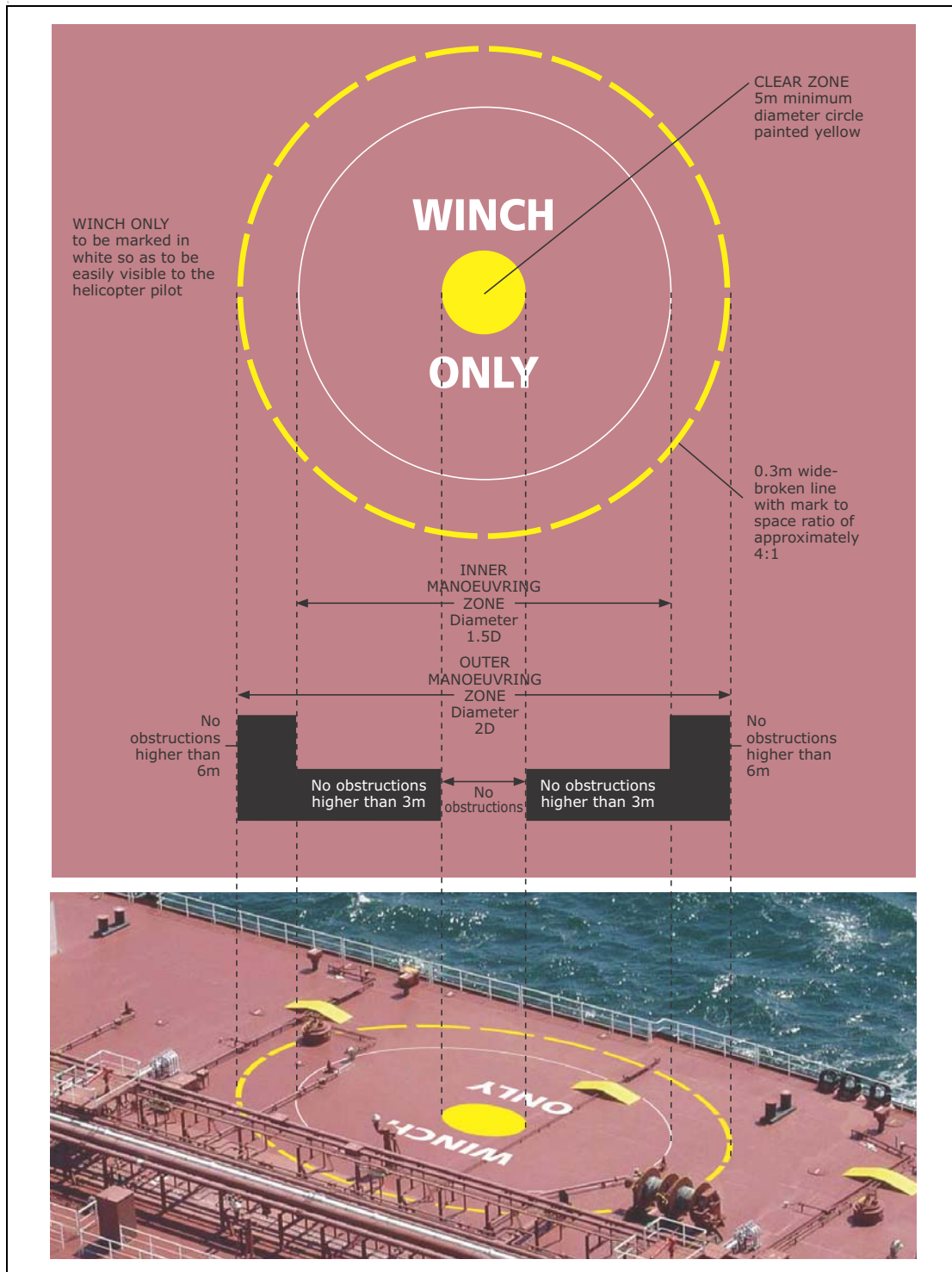

**Figure 1** Winching Area Arrangement on a Vessel<sup>1</sup>

1. Figure courtesy of International Chamber of Shipping, Helicopter Ship Guide (2008).

## 1.5 Obstructions

- 1.5.1 To reduce the risk of a hoist hook or cable becoming fouled, all guard rails, awnings, stanchions, antennae and other obstructions within the vicinity of the manoeuvring zone should, as far as possible, be either removed, lowered or securely stowed.
- 1.5.2 All dominant obstacles within, or adjacent to, the manoeuvring zone should be conspicuously marked and, for night operations, be adequately illuminated (see paragraphs 1.4.5 and 1.4.6. Also see Chapter 4, paragraph 4).

## 1.6 Hoisting Above Accommodation Spaces

- 1.6.1 Some vessels may only be able to provide winching areas which are situated above accommodation spaces. Due to the constraints of operating above such an area only twin-engined helicopters should be used for such operations and the following procedures adhered to:
- Personnel should be cleared from all spaces immediately below the helicopter operating area and from those spaces where the only means of escape is through the area immediately below the operating area.
  - Safe means of access to and escape from the operating area should be provided by at least two independent routes.
  - All doors, ports, skylights etc. in the vicinity of the aircraft operating area should be closed. This also applies to deck levels below the operating area.

Fire and rescue personnel should be deployed in a ready state but sheltered from the helicopter operating area.

## 2 Helicopter Winching Areas on Wind Turbine Platforms

- NOTES:**
- CAP 764 provides CAA policy and guidelines on wind turbines.
  - Helicopter hoist operations to wind turbine platforms should be conducted by day in Visual Meteorological Conditions (VMC) only.
  - The platform design criteria in the following paragraphs have been developed to promote a 'safe and friendly' environment for helicopter hoist operations. It should be recognised that any departure from 'best practice' topside arrangements / platform designs laid out in paragraphs 2.1 and 2.2, including deviations from specified dimensions, has potential to compromise the 'safe and friendly' environment secured for helicopter hoist operations. Therefore any proposed conceptual arrangements should be subjected to appropriate testing including wind tunnel testing and/or CFD studies to establish the wind environment at and above the operating area. Studies undertaken should assess any impact on safe operations that may be caused by an increase in the incidence of turbulence and/or of rotor downwash effects as a result of proposed modified topside arrangements / platform design.

### 2.1 Platform Design

- 2.1.1 The winching area platform (clear area) should be square or rectangular and capable of containing a circle having a minimum diameter of 4.0 m.
- 2.1.2 In addition to the winching area platform, provision needs to be made for a safety zone to accommodate Helicopter Hoist Operations Passengers (HHOP) at a safe distance away from the winching area during helicopter hoist operations. The minimum safe distance is deemed to be not less than 1.5 m from the inboard edge of the winching (clear) area.

- 2.1.3 The safety zone should be connected by an access route to the winching area platform located inboard of the winching area platform. The safety zone and associated access route should have the same surface characteristics as the winching area platform (see paragraphs 2.1.5, 2.1.6 and 2.1.7) except that the overall size may be reduced, such that the dimensions of the safety zone and access route are not less than 2.5 m (length) x 0.9 m (width).
- NOTE:** The dimensions of the safety zone may need to be increased according to the maximum number of HHOP that need to be accommodated safely away from the winching (clear) area during helicopter hoist operations.
- 2.1.4 To differentiate the safety zone and the associated access route from the winching area, it is recommended that the safety zone and access route be painted in contrasting colours to indicate to HHOP where it is safe to congregate during helicopter hoist operations (see paragraph 2.3.1 and Figure 2).
- 2.1.5 The platform should be constructed so that it generates as little turbulence as possible. The overall platform design should take account of the need for downdraft from the main rotor to disperse away from the platform. The incidence regarding the discharge of static electricity from the helicopter should be addressed by ensuring that the platform is capable of grounding the hoist wire and aircraft.
- 2.1.6 The platform deck should be capable of supporting a mass that is approximately five times the weight of an average HHOP.
- 2.1.7 The surface of the platform, including the safety zone and associated access route, should display suitable friction characteristics to ensure the safe movement of HHOP in all conditions.
- 2.1.8 The winching area platform and associated access route and safety zone should be completely enclosed by a 1.5 m high railing system to ensure the safety and security of HHOP at all times. The design of the safety rails should ensure that a free flow of air through the structure is not prevented or disrupted whilst also guaranteeing that no possibility exists for the hoist hook to get entangled in the railing or in any other part of the platform structure.
- 2.1.9 The surface of the platform should be essentially flat for helicopter hoist operations. However, the floor may slope down towards the outboard edge of the platform to prevent the pooling of water on the platform. It is recommended that a slope not exceeding 2% (1:50) be provided.
- 2.1.10 The outboard edge of the winching area platform should be located at a minimum horizontal distance from the plane of rotation of the turbine blades that is not less than 1 x the Rotor Diameter (RD) of the largest helicopter intending to conduct hoist operations to the platform. For single main rotor types, the RD is assumed to represent the largest overall width dimension of the helicopter, so that for the widest helicopter authorised to operate to the platform, when located with the centre of the disc directly above the outboard edge of the platform (as depicted in Figure 3), a minimum rotor-tip-to-obstacle clearance of  $\frac{1}{2}$  RD (i.e. one rotor radius) is assured. To make allowance for circumstances that may require a helicopter in the hover to move laterally from the edge of the platform in the direction of the turbine blades, a reduction in the minimum rotor-tip-to-obstacle clearance below  $\frac{1}{2}$  RD may be permitted. However, in no circumstances should the clearance between the tip-path plane of the main rotor and the plane of rotation of the turbine blades be reduced below 4 m for any helicopter intending to conduct hoist operations to the platform.



2.1.11 During helicopter hoist operations, it is essential that the nacelle should not turn in azimuth and that the turbine blades should also be prevented from rotating by the application of the braking system. Experience in other sectors indicates that it is normal practice for the nacelle to be motored 90 degrees out of wind so that the upwind blade is horizontal and points into the prevailing wind. This is considered to be the preferred orientation for helicopter hoist operations; however, the actual orientation of the blades may vary to suit specific operational requirements.

## 2.2 **Obstacle Restriction**

2.2.1 Within a horizontal distance of 1.5 m measured from the winching (clear) area, no obstacles are permitted to extend above the top of the 1.5 m railing.

2.2.2 Beyond 1.5 m, and out to a distance corresponding to the plane of rotation of the turbine rotor blades, obstacles are permitted up to a height not exceeding 3 m above the surface of the winching area. It is required that only fixed obstacles essential to the safety of the operation are present, e.g. anemometer masts, communications antennae, helihoist status light etc.

## 2.3 **Visual Aids**

2.3.1 The surface of the winching area (a minimum 4 m square 'clear area') should be painted yellow. For the safety zone, green is recommended and a contrasting grey for the associated access route (see Figure 2).

2.3.2 The railings around the entire winching area, safety zone and associated access route should be painted in a conspicuous colour, preferably red.

2.3.3 The wind turbine structure should be clearly identifiable from the air using a simple designator (typically a two-digit or three-digit number with block identification), painted in 1.2 m (minimum) characters in a contrasting colour, preferably black. The turbine designator should be painted on the nacelle top cover ideally utilising an area adjacent to the turbine rotor blades.

2.3.4 A procedure should be put in place to indicate to the helicopter operator that the turbine blades and nacelle are safely secured in position prior to helicopter hoist operations commencing. Experience in other sectors has demonstrated that this may be achieved by the provision of a helihoist status light located on the nacelle within the pilot's field of view, which is capable of being operated remotely and from the platform itself or from within the nacelle. The system commonly used is a green light capable of displaying in both steady and flashing signal mode. A steady green light is displayed to indicate to the pilot that the turbine blades and nacelle are secure and it is safe to operate. A flashing green light is displayed to indicate that the turbine is in a state of preparation to accept hoist operations or, when displayed during hoist operations, that parameters are moving out of limits. When the light is extinguished this indicates to the operator that it is **not** safe to conduct helicopter hoist operations.

2.3.5 Requirements for lighting of wind turbine generators in United Kingdom territorial waters, aimed at 'warning off' aircraft transiting the generic area, are addressed in Article 220 of the ANO 2009. See also Directorate of Airspace Policy – Policy Statement for The Lighting of Wind Turbine Generators in United Kingdom Territorial Waters.

2.3.6 Obstruction lighting in the vicinity of the winching area that has a potential to cause glare or dazzle to the pilot or to a helicopter hoist operations crew member should be switched off prior to, and during, helicopter hoist operations.

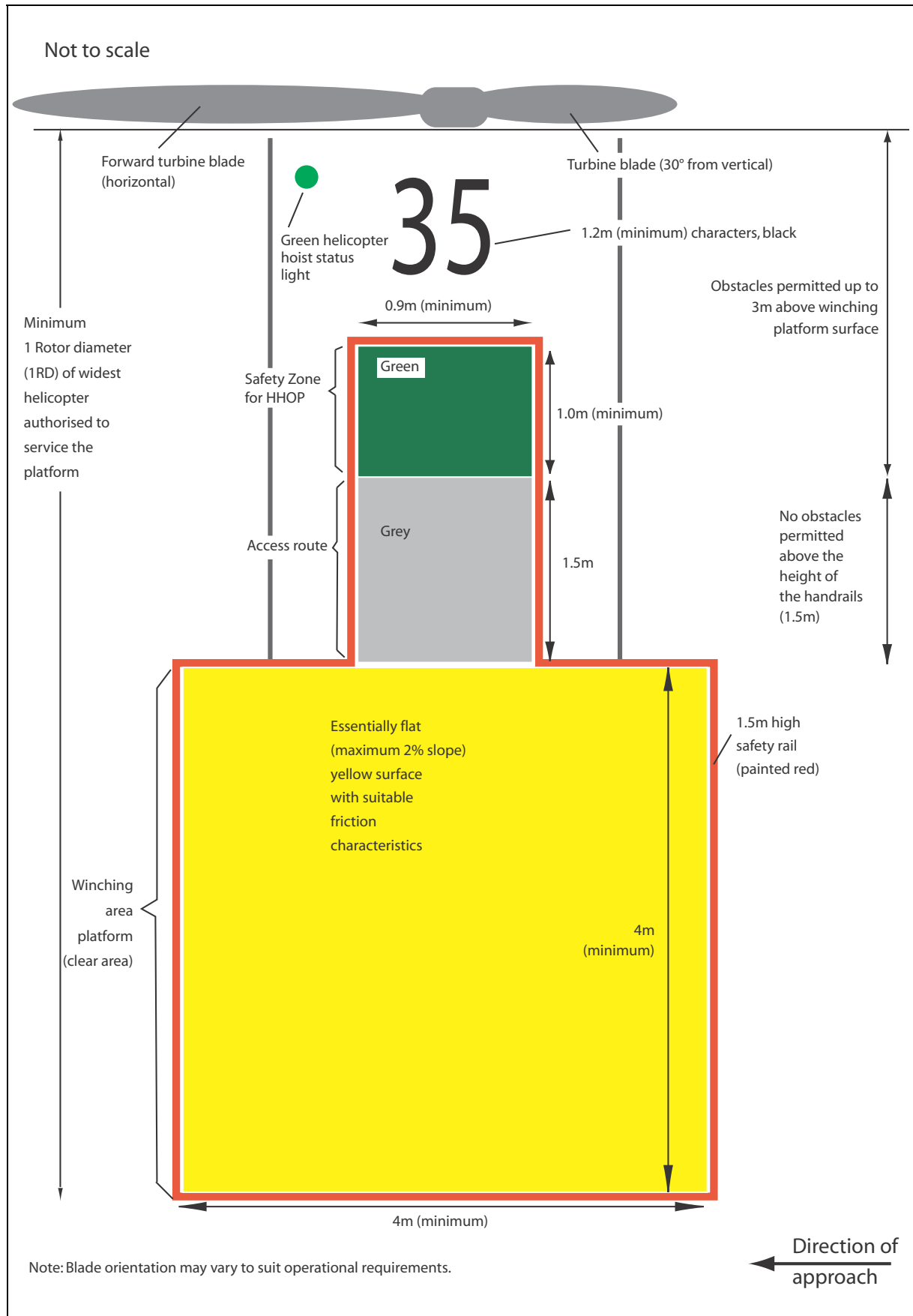

**Figure 2** Winching Area, Access Route and Safety Zone

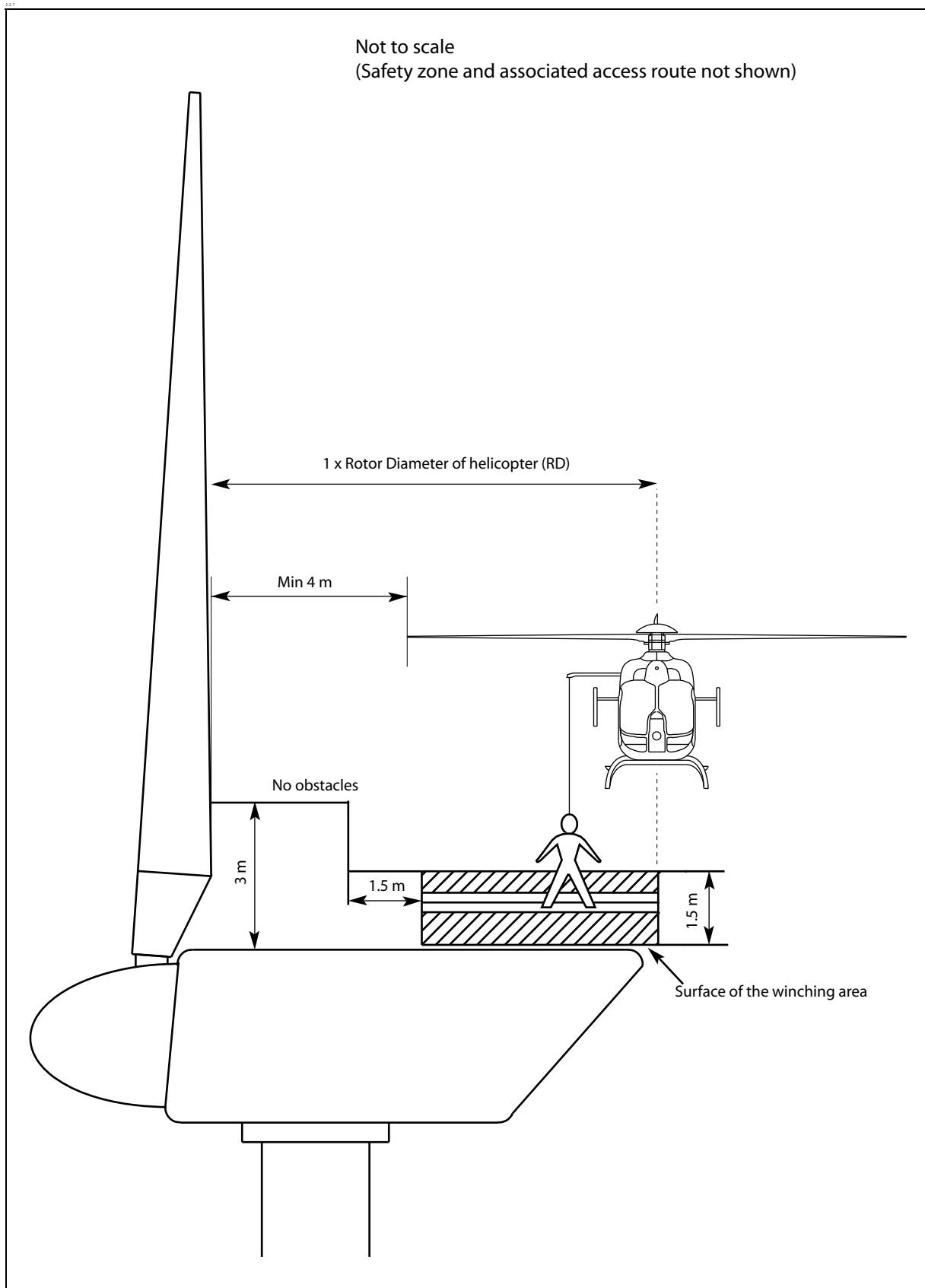

**Figure 3** General Arrangement Drawing Showing Surfaces and Sectors

## 2.4 **Further Operational Considerations**

- 2.4.1 For UK operations it is understood to be normal practice for the hoist arrangement to be located on the right hand side of the helicopter with the pilot positioned just on the inboard side of the outboard winching (clear area) platform railings (see Figure 3). In this configuration the pilot's perspective of the platform and turbine blade arrangement should be unimpeded and it is not considered usually necessary to provide any additional visual cues to assist in the maintenance of a safe lateral distance between the helicopter main rotor and the nearest dominant obstacle.
- 2.4.2 Where cross-cockpit helicopter hoist operations are envisaged an aiming point system may need to be established to assist the pilot in determining the position of the helicopter in relation to the winching area platform and to obstacles. This may be achieved by the provision of a sight point marker system or similar aids. Further guidance may be obtained from Flight Operations Inspectorate (Helicopters) Section.
- 2.4.3 Specific operational guidance is being prepared for CAP 789. It is recommended that helicopter hoist operators consult this additional source.

## Appendix A Checklist

The following 'checklist' is based on extracts from JAR-OPS 3 Section 2 Subpart D, AMC No. 2 to OPS 3.220, which provides in specific and detailed terms the minimum criteria which need to be assessed when determining the acceptability of a helicopter landing area on an offshore installation or vessel. The CAA considers that as a minimum these issues should be examined during periodic surveys to confirm that there has been no alteration or deterioration in the condition of the helicopter landing area.

**a) The physical characteristics of the helideck:**

- i) Dimensions as measured;
- ii) Declared D-value;
- iii) Deck shape; and
- iv) Scale drawings of deck arrangement.

**b) The preservation of obstacle-protected surfaces is the most basic safeguard for all flights. These surfaces are:**

- i) The minimum 210° Obstacle Free Sector (OFS) surface;
- ii) The 150° Limited Obstacle Sector (LOS) surface; and
- iii) The minimum 180° falling 5:1 gradient surface with respect to significant obstacles.

If one or more of these surfaces is infringed due, for example, to the proximity of an adjacent installation or vessel, an assessment should be made to determine any possible negative effect which may lead to operating restrictions.

**c) Marking and lighting:**

- i) Adequate helideck perimeter lighting;
- ii) Adequate helideck touchdown marking lighting ("H" and TD/PM Circle lighting) and/or floodlighting;
- iii) Status lights (for day and night operations);
- iv) Helideck markings;
- v) Dominant obstacle paint schemes and lighting; and
- vi) General installation lighting levels including floodlighting.

Where inadequate helideck lighting exists the Helideck Limitation List (HLL) should be annotated 'daylight only operations'.

**d) Deck surface:**

- i) Surface friction;
- ii) Helideck net (as applicable);
- iii) Drainage system;
- iv) Deck edge perimeter safety netting;
- v) Tie-down points; and
- vi) Cleaning of all contaminants (to maintain satisfactory recognition of helideck markings and preservation of the helideck friction surface).

**e) Environment:**

- i) Foreign object damage;
- ii) Air quality degradation due to exhaust emissions, hot and cold vented gas emissions and physical turbulence generators;
- iii) Bird control;
- iv) Any adjacent helideck/installation environmental effects may need to be included in any air quality assessment; and
- v) Flares.

**f) Rescue and Fire Fighting:**

- i) Primary and complementary media types, quantities, capacity and systems;
- ii) Personal Protective Equipment (PPE); and
- iii) Crash box.

**g) Communications and navigation:**

- i) Aeronautical radio(s);
- ii) Radio/telephone (R/T) call sign to match helideck name and side identification which should be simple and unique;
- iii) Non-Directional Beacon (NDB) or equivalent (as appropriate); and
- iv) Radio log.

**h) Fuelling facilities:**

- i) In accordance with relevant national guidance and regulations.

**i) Additional operational and handling equipment:**

- i) Windsock;
- ii) Meteorological information (recorded by an automated means);
- iii) Helideck Motion System recording and reporting (where applicable);
- iv) Passenger briefing system;
- v) Chocks;
- vi) Tie-downs; and
- vii) Weighing scales for passengers, baggage and freight.

**j) Personnel:**

- i) Trained helicopter staff (e.g. Helicopter Landing Officer, Helideck Assistant and fire-fighters).

**k) Other:**

- i) As appropriate.

**NOTE:** AMC No. 2 to OPS 3.220 also provides detailed guidance on the format and content of the HLL and the Helideck template (the HIP) which are required to be provided as part of the helideck approvals process.

# Appendix B Bibliography

## 1 References

Where a chapter is indicated below it shows where in this CAP the document is primarily referenced.

### Health and Safety Executive

#### Chapter

- |   |                                                                                                                                                                                                 |
|---|-------------------------------------------------------------------------------------------------------------------------------------------------------------------------------------------------|
| 1 | A guide to the Integrity, Workplace Environment and Miscellaneous Aspects of the Offshore Installations and Wells (Design and Construction, etc.) Regulations 1996 HSE Books ISBN 0 7176 1164 7 |
| 1 | A guide to the Offshore Installations (Safety Case) Regulations 2005, Third edition 2006 HSE Books, ISBN 0 7176 6184 9                                                                          |
| 1 | A guide to the Offshore Installations and Pipeline Works (Management and Administration) Regulations 1995 HSE Books ISBN 0 7176 0938 3                                                          |
| 4 | Operations Notice No. 39: Guidance on identification of offshore installations, June 2008                                                                                                       |
| 1 | Operations Notice No. 67: Offshore Helideck Design Guidelines, October 2004                                                                                                                     |
| 3 | Offshore Helideck Design Guidelines (available online at <a href="http://www.hse.gov.uk">www.hse.gov.uk</a> )                                                                                   |
| 3 | Offshore Information Sheet No. 5/2011: Offshore helideck design considerations – environment effects, June 2011                                                                                 |
| 5 | Offshore Information Sheet No. 6/2011: Offshore helidecks – testing of helideck foam production systems, August 2011                                                                            |
| 1 | Prevention of Fire and Explosion, and Emergency Response on Offshore Installations, Approved Code of Practice and Guidance 1995, HSE Books ISBN 0 7176 0874 3                                   |

### International Civil Aviation Organization

ICAO Annex 3	Meteorological Service for International Air Navigation
ICAO Annex 14 Volume II	Heliports
ICAO Doc 9261 AN/903	Heliport Manual
ICAO Doc 9284 AN/905	Technical Instruction for the Safe Transport of Dangerous Goods by Air

### Other Publications

Chapter		
9	Guide to Helicopter/Ship Operations, International Chamber of Shipping, Fourth Edition, December 2008	
8	Helicopter Refuelling Handbook (5 <sup>th</sup> Edition, 2007)	
3	IMO (International Maritime Organization)	Mobile Offshore Drilling Units (MODU) Code (2001 consolidated)
3	ISO (International Organization for Standardization)	International Standard ISO 19901-3: Petroleum and Natural Gas Industries – Specific Requirements for Offshore Structures, Part 3: topsides structure (2010-12-10) www.iso.org
5	Offshore Petroleum Industry Training Organisation (OPITO) Helicopter Landing Officer's Handbook (8 <sup>th</sup> Edition, 2007)	
3	Oil & Gas UK	Guidelines for the Management of Aviation Operations (Issue 6 – April 2011)
6	Oil & Gas UK	Guidelines for Safety Related Telecommunications Systems On Fixed Offshore Installations
3	Review of falling 5-in-1 Gradient Criteria of Offshore Platform Operations. Dr Douglas G Thomson/Prof Roy Bradley – Final Report March 1997 Dr Douglas G Thomson – Addendum to Final Report – July 1999	
6	WMO (World Meteorological Organization) Publication No. 306 Manual on Codes Volume 1.1, Part A Alphanumeric Codes, Code Table 3700 State of the Sea	

### Civil Aviation Authority – CAPs, Research Papers and Policy Statements

Chapter		
3	CAA Paper 99004	Research on Offshore Helideck Environmental Issues
4	CAA Paper 2004/01	Enhancing Offshore Helideck Lighting – NAM K14 Trials
4	CAA Paper 2005/01	Enhancing Offshore Helideck Lighting – Onshore Trials at Longside airfield
4	CAA Paper 2006/03	Enhancing Offshore Helideck Lighting – Onshore Trials at Norwich Airport
3	CAA Paper 2007/02	Visualisation of Offshore Gas Turbine Exhaust Plumes
4	CAA Paper 2008/01	Specification for an Offshore Helideck Status Light System
3	CAA Paper 2008/02 Study I	Validation of the Helicopter Turbulence Criterion for Operations to Offshore Platforms



3	CAA Paper 2008/02 Study II	A review of 0.9 m/s Vertical Wind Component Criterion for Helicopters Operating to Offshore Installations
3	CAA Paper 2008/03	Helideck Design Considerations: Environmental Effects
4	CAA Paper 2012/03	Specification for an Offshore Helideck Lighting System
6	CAP 413	Radiotelephony Manual
6	CAP 452	Aeronautical Radio Station Operator's Guide
6	CAP 670	Air Traffic Services Safety Requirements
6	CAP 746 (Appendix H)	Meteorological Observations at Aerodromes (Competency of Observers)
7	CAP 748	Aircraft Fuelling and Fuel Installation Management
10	CAP 764	CAA Policy and Guidelines on Wind Turbines
10	CAP 789	Requirements and Guidance Material for Operators
10	DAP Policy Statement	The Lighting of Wind Turbine Generators in United Kingdom Territorial Waters

## 2 Sources

British Standards (BS) may be obtained from Her Majesty's Stationery Office, PO Box 276, Nine Elms Lane, London SW8 5DT. Telephone +44 (0) 20 7211 5656 or from any HMSO. Advice on relevant codes (BS, EN and PREN) is available from the CAA at SRG Gatwick.

Civil Aviation Publications (CAPs) and Civil Aviation Authority Papers (CAA Papers) are published on the CAA website at [www.caa.co.uk](http://www.caa.co.uk) where you may register for e-mail notification of amendments. Please see the inside cover of this CAP for details of availability of paper copy.

HSE Publications from HSE Books, PO Box 1999, Sudbury, Suffolk, CO10 2WA. Telephone +44 (0) 1787 881165 or e-mail [hsebooks@prolog.uk.com](mailto:hsebooks@prolog.uk.com). Most documents can be downloaded from HSE's website [www.hse.gov.uk](http://www.hse.gov.uk).

ICAO Publications are available from Airplan Flight Equipment, 1a Ringway Trading Estate, Shadowmoss Road, Manchester M22 5LH. Telephone +44 (0) 161 499 0023. The ICAO website address is [www.icao.int](http://www.icao.int).

International Chamber of Shipping Publications from International Chamber of Shipping, 12 Carthusian Street, London, EC1M 6EZ. Telephone +44 (0) 20 7417 2855. E-mail [publications@marisec.org](mailto:publications@marisec.org).

Oil & Gas UK Publications from Oil & Gas UK, 2nd Floor, 232-242 Vauxhall Bridge Road, London SW1V 1AU. Telephone +44 (0) 20 7802 2400. Website [www.oilandgas.org.uk](http://www.oilandgas.org.uk). E-mail [info@oilandgasuk.co.uk](mailto:info@oilandgasuk.co.uk).

OPITO Publications from OPITO, Inchbraoch house, South Quay, Ferryden, Montrose, Scotland, DD10 9SL. Telephone +44 (0) 1674 662500.

INTENTIONALLY LEFT BLANK

# Appendix C Specification for Helideck Lighting Scheme Comprising: Perimeter Lights, Lit Touchdown/Positioning Marking and Lit Heliport Identification Marking

## 1 Overall Operational Requirement

- 1.1 The whole lighting scheme should be visible over a range of 360° in azimuth. Although on some offshore installations the helideck may be obscured by topsides structure in some approach directions, the lighting configuration on the helideck need not take this into account.
- 1.2 The visibility of the lighting scheme should be compatible with the normal range of helicopter vertical approach paths from a range of two nautical miles (NM).
- 1.3 The purpose of the lighting scheme is to aid the helicopter pilot perform the necessary visual tasks during approach and landing as stated in Table 1.

**Table 1** Visual Tasks During Approach and Landing

Phase of Approach	Visual Task	Visual Cues/Aids	Desired Range (NM)	
			5000 m met. vis.	1400 m met. vis.
Helideck Location and Identification	Search within platform structure.	Shape of helideck; colour of helideck; luminance of helideck perimeter lighting.	1.5 (2.8 km)	0.75 (1.4 km)
Final Approach	Detect helicopter position in three axes.  Detect rate of change of position.	Apparent size/shape and change of size/shape of helideck. Orientation and change of orientation of known features/markings/lights.	1.0 (1.8 km)	0.5 (900 m)
Hover and Landing	Detect helicopter attitude, position and rate of change of position in three axes (six degrees of freedom).	Known features/markings/lights. Helideck texture.	0.03 (50 m)	0.03 (50 m)

- 1.4 The minimum intensities of the lighting scheme should be adequate to ensure that, for a minimum Meteorological Visibility (Met. Vis.) of 1400 m and an illuminance threshold of  $10^{-6.1}$  lux, each feature of the system is visible and usable at night from ranges in accordance with paragraphs 1.5, 1.6 and 1.7.
- 1.5 The perimeter lights are to be visible at night from a minimum range of 0.75 NM.
- 1.6 The TD/PM Circle on the helideck is to be visible at night from a minimum range of 0.5 NM.
- 1.7 The Heliport Identification Marking ('H') is to be visible at night from a minimum range of 0.25 NM.
- 1.8 The minimum ranges at which the TD/PM Circle and 'H' are visible and usable (see paragraphs 1.6 and 1.7) should still be achieved even where a correctly fitted landing net covers the lighting.
- 1.9 The design of the perimeter lights, TD/PM Circle and 'H' should be such that the luminance of the perimeter lights is equal to or greater than that of the TD/PM Circle segments, and the luminance of the TD/PM Circle segments is equal to or greater than that of the 'H'.
- 1.10 The design of the TD/PM Circle and 'H' should include a facility to increase their intensity to twice the minimum figures given in this specification to permit a once-off (tamper proof) adjustment at installation; the maximum figures should not be exceeded. The purpose of this facility is to ensure adequate performance at installations with high levels of background lighting without risking glare at less well-lit installations. The TD/PM Circle and 'H' should be adjusted together using a single control to ensure that the balance of the overall lighting system is maintained in both the 'standard' and 'bright' settings.

## 2 Definitions

2.1 The following definitions should apply:

### 2.1.1 Lighting Element

A lighting element is a light source within a segment or sub-section and may be individual (e.g. a Light Emitting Diode (LED)) or continuous (e.g. fibre optic cable, electroluminescent panel). An individual lighting element may consist of a single light source or multiple light sources arranged in a group or cluster.

### 2.1.2 Segment

A segment is a section of the TD/PM Circle lighting. For the purposes of this specification, the dimensions of a segment are the length and width of the smallest possible rectangular area that is defined by the outer edges of the lighting elements, including any lenses.

### 2.1.3 Sub-Section

A sub-section is an individual section of the 'H' lighting. For the purposes of this specification, the dimensions of a sub-section are the length and width of the smallest possible rectangular area that is defined by the outer edges of the lighting elements, including any lenses.

### 3 The Perimeter Light Requirement

#### 3.1 Configuration

Perimeter lights, spaced at intervals of not more than 3 m, should be fitted around the perimeter of the landing area of the helideck.

#### 3.2 Mechanical Constraints

For any helideck where the D-value is greater than 16.00 m, the perimeter lights when installed should not exceed a height of 25 cm above the surface of the helideck. Where a helideck has a D-value of 16.00 m or less, the perimeter lights when installed should not exceed a height of 5 cm above the surface of the helideck.

#### 3.3 Light Intensity

The minimum light intensity profile is given in Table 2 below:

**Table 2** Minimum Light Intensity Profile for Perimeter Lights

Elevation	Azimuth	Intensity (min)
0° to 10°	-180° to +180°	30 cd
>10° to 20°	-180° to +180°	15 cd
>20° to 90°	-180° to +180°	3 cd

No perimeter light should have a luminous intensity of greater than 60 cd at any angle of elevation. Note that the design of the perimeter lights should be such that the luminance of the perimeter lights is equal to or greater than that of the TD/PM Circle segments.

#### 3.4 Colour

The colour of the light emitted by the perimeter lights should be green, as defined in ICAO Annex 14 Volume 1 Appendix 1, paragraph 2.1.1(c), whose chromaticity lies within the following boundaries:

$$\text{Yellow boundary} \quad x = 0.360 - 0.080y$$

$$\text{White boundary} \quad x = 0.650y$$

$$\text{Blue boundary} \quad y = 0.390 - 0.171x$$

#### 3.5 Serviceability

The perimeter lighting is considered serviceable provided that at least 90% of the lights are serviceable, and providing that any unserviceable lights are not adjacent to each other.

### 4 The Touchdown/Positioning Marking Circle Requirement

#### 4.1 Configuration

The lit TD/PM Circle should be superimposed on the yellow painted marking. It should comprise one or more concentric circles of at least 16 discrete lighting segments, of 40 mm minimum width. A single circle should be positioned at the mean radius of the painted circle. Multiple circles should be symmetrically disposed about the mean radius of the painted circle. The lighting segments should be of such a length as to provide coverage of between 50% and 75% of the circumference and be equidistantly placed with the gaps between them not less than 0.5 m. The mechanical housing should be coloured yellow – see CAP 437, Chapter 4, paragraph 2.11.

4.2 **Mechanical Constraints**

4.2.1 The height of the segments and lighting elements of the TD/PM Circle and any associated cabling should be as low as possible and should not exceed 25 mm. The overall height of the system, taking account of any mounting arrangements, should be kept to a minimum. So as not to present a trip hazard, the segments should not present any vertical outside edge greater than 6 mm without chamfering at an angle not exceeding 30° from the horizontal.

4.2.2 The overall effect of the lighting strips and cabling on deck friction should be minimised. Wherever practical, the surfaces of the lighting segments should meet the minimum deck friction limit coefficient ( $\mu$ ) of 0.65, e.g. on non-illuminated surfaces.

4.2.3 The TD/PM Circle lighting components, fittings and cabling should be able to withstand a pressure of at least 1,655 kPa (240 lb/in<sup>2</sup>) and ideally 2,280 kPa (331 lb/in<sup>2</sup>) without damage.

4.3 **Intensity**

4.3.1 The light intensity for each of the lighting segments, when viewed at angles of azimuth over the range +80° to -80° from the normal to the longitudinal axis of the strip (see Figure 1), should be as defined in Table 3.

**Table 3** Light Intensity for Lighting Segments on the TD/PM Circle

Elevation	Intensity	
	Min	Max
>0° to 10°	As a function of segment length as defined in Figure 2	60 cd
>10° to 20°	25% of min intensity >0° to 10°	45 cd
>20° to 90°	5% of min intensity >0° to 10°	15 cd

4.3.2 For the remaining angles of azimuth on either side of the longitudinal axis of the segment, the maximum intensity should be as defined in Table 3.

4.3.3 Note that the intensity of each lighting segment should be nominally symmetrical about its longitudinal axis.

4.3.4 Note also that the design of the TD/PM Circle should be such that the luminance of the TD/PM Circle segments is equal to or greater than the sub-sections of the 'H'.

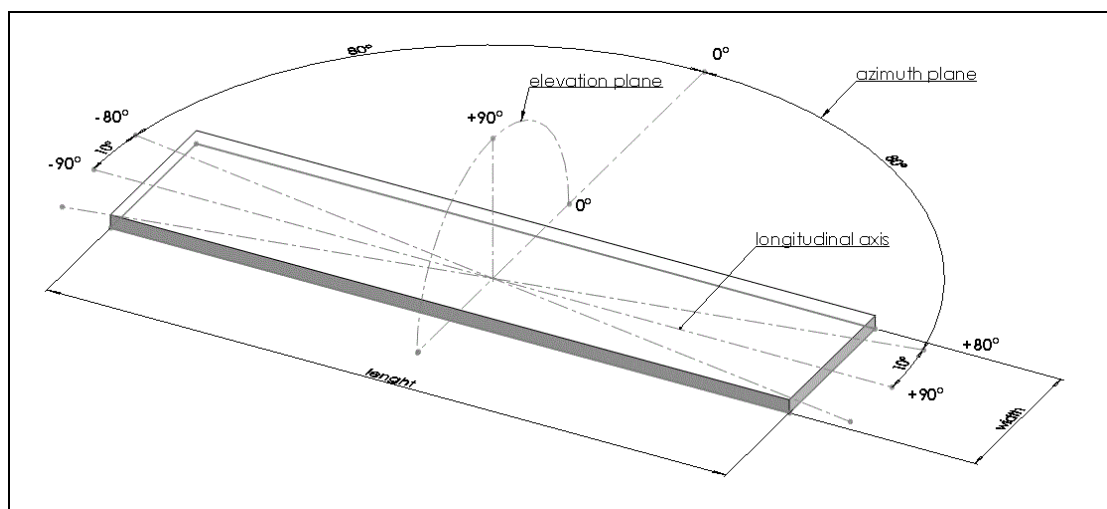

**Figure 1** TD/PM Segment Measurement Axis System

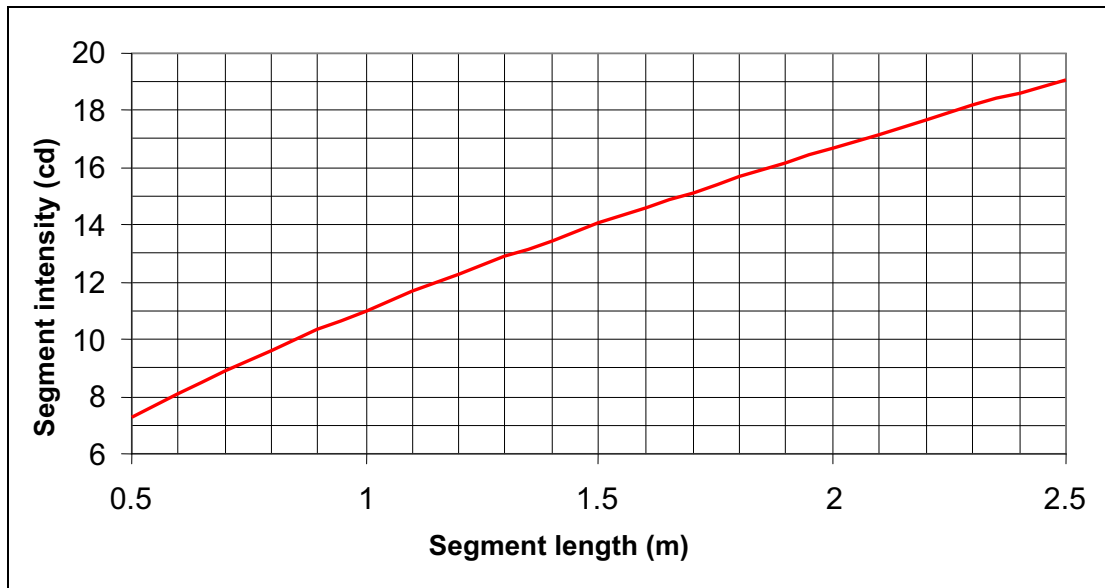

**Figure 2** TD/PM Segment Intensity versus Segment Length

**NOTE:** Given the minimum gap size of 0.5 m and the minimum coverage of 50%, the minimum segment length is 0.5 m. The maximum segment length depends on deck size, but is given by selecting the minimum number of segments (16) and the maximum coverage (75%).

- 4.3.5 If a segment is made up of a number of individual lighting elements (e.g. LEDs) then they should be the same nominal performance (i.e. within manufacturing tolerances) and be equidistantly spaced throughout the segment to aid textural cueing. Minimum spacing should be 3 cm and maximum spacing 10 cm. The minimum intensity of each lighting element ( $i$ ) should be given by the formula:

$$i = I / n$$

where:  $I$  = required minimum intensity of segment at the 'look down' (elevation) angle (see Table 3).

$n$  = the number of lighting elements within the segment.

- 4.3.6 If the segment comprises a continuous lighting element (e.g. fibre optic cable, electroluminescent panel), then to achieve textural cueing at short range, the element should be masked at 3 cm intervals on a 1:1 mark:space ratio.

#### 4.4 Colour

The colour of the light emitted by the TD/PM Circle should be yellow, as defined in ICAO Annex 14 Volume 1 Appendix 1, paragraph 2.1.1(b), whose chromaticity lies within the following boundaries:

Red boundary  $y = 0.382$

White boundary  $y = 0.790 - 0.667x$

Green boundary  $y = x - 0.120$

#### 4.5 Serviceability

The TD/PM Circle is considered serviceable provided that at least 90% of the segments are serviceable. A TD/PM Circle segment is considered serviceable provided that at least 90% of the lighting elements are serviceable.

## 5 The Heliport Identification Marking Requirement

### 5.1 Configuration

- 5.1.1 The lit Heliport Identification Marking ('H') should be superimposed on the 4 m x 3 m white painted 'H' (limb width 0.75 m). The limbs should be lit in outline form as shown in Figure 3.

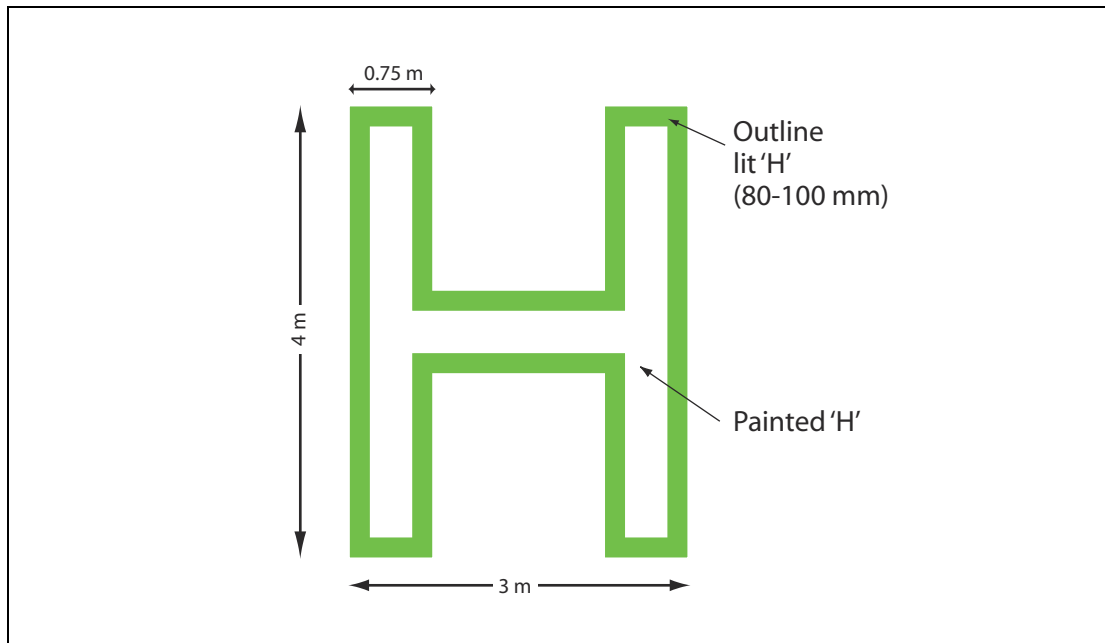

**Figure 3** Configuration and Dimensions of Heliport Identification Marking 'H'

- 5.1.2 An outline lit 'H' should comprise sub-sections of between 80 mm and 100 mm wide around the outer edge of the painted 'H' (see Figure 3). There are no restrictions on the length of the sub-sections, but the gaps between them should not be greater than 10 cm. The mechanical housing should be coloured white – see CAP 437, Chapter 4, paragraph 2.11.

### 5.2 Mechanical Constraints

- 5.2.1 The height of the subsections and lighting elements of the lit 'H' and any associated cabling should be as low as possible and should not exceed 25 mm. The overall height of the system, taking account of any mounting arrangements, should be kept to a minimum. So as not to present a trip hazard, the lighting strips should not present any vertical outside edge greater than 6 mm without chamfering at an angle not exceeding 30° from the horizontal.
- 5.2.2 The overall effect of the lighting sub-sections and cabling on deck friction should be minimised. Wherever practical, the surfaces of the lighting sub-sections should meet the minimum deck friction limit coefficient ( $\mu$ ) of 0.65, e.g. on non-illuminated surfaces.
- 5.2.3 The 'H' lighting components, fitments and cabling should be able to withstand a pressure of at least 1,655 kPa (240 lb/in<sup>2</sup>) and ideally 2,280 kPa (331 lb/in<sup>2</sup>) without damage.



### 5.3 Intensity

- 5.3.1 The intensity of the lighting along the 4 m edge of an outline 'H' over all angles of azimuth is given in Table 4 below.

**Table 4** Light Intensity of the 4 m Edge of the 'H'

Elevation	Intensity	
	Min	Max
2° to 12°	3.5 cd	60 cd
>12° to 20°	0.5 cd	30 cd
>20° to 90°	0.2 cd	10 cd

**NOTE:** For the purposes of demonstrating compliance with this specification, a sub-section of the lighting forming the 4 m edge of the 'H' may be used. The minimum length of the sub-section should be 0.5 m.

- 5.3.2 The 'H' should consist of the same lighting element material throughout.
- 5.3.3 If the 'H' is made up of individual lighting elements (e.g. LEDs) then they should be of nominally identical performance (i.e. within manufacturing tolerances) and be equidistantly spaced within the limb to aid textural cueing. Minimum spacing should be 3 cm and maximum spacing 10 cm. The intensity of each lighting element (i) should be given by the formula:

$$i = I / n$$

where: I = intensity of the segment between 2° and 12°.

n = the number of lighting elements within the segment.

- 5.3.4 If the 'H' is constructed from a continuous lighting element (e.g. fibre optic cables or panels, electroluminescent panels), the luminance (B) of the 4 m edge of the outline 'H' should be given by the formula:

$$B = I / A$$

where: I = intensity of the limb (see Table 4).

A = the projected lit area at the 'look down' (elevation) angle.

### 5.4 Colour

The colour of the 'H' should be green, as defined in ICAO Annex 14 Volume 1 Appendix 1, paragraph 2.1.1(c), whose chromaticity lies within the following boundaries:

Yellow boundary  $x = 0.360 - 0.080y$

White boundary  $x = 0.650y$

Blue boundary  $y = 0.390 - 0.171x$

### 5.5 Serviceability

The 'H' is considered serviceable provided that at least 90% of the sub-sections are serviceable. An 'H' sub-section is considered serviceable provided that at least 90% of the lighting elements are serviceable.

## 6 Other Considerations

- 6.1 All lighting components and fitments should meet safety regulations relevant to a helideck environment such as explosion proofing (Zone 1 or 2 as appropriate) and flammability (by a notified body in accordance with the ATEX directive).
- 6.2 All lighting components and fitments installed on the surface of the helideck should be resistant to attack by fluids such as fuel, hydraulic fluid, and those used for de-icing, cleaning and fire-fighting. In addition they should be resistant to UV light, rain, sea spray, guano, snow and ice. Installation arrangements for the lighting components and fitments should be acceptable to the CAA.
- 6.3 All lighting components and fitments that are mounted on the surface of the helideck should be able to operate within a temperature range appropriate for the local ambient conditions.
- 6.4 All lighting components and fitments should, as a minimum, meet IEC International Protection (IP) standard IP66, i.e. dust tight and resistant to powerful water jetting.
- 6.5 All cabling should utilise low smoke/toxicity, flame retardant cable. Any through-the-deck cable routing and connections should use sealed glands, type approved for helideck use.
- 6.6 All lighting components should be tested by an independent test house. The optical department of this test house should be accredited according to ISO/IEC 17025.
- 6.7 Provision should be included in the design of the system to allow for the drainage of the helideck, in particular the area inside the TD/PM Circle.

# Appendix D Helideck Fire-Fighting Provisions for Existing Normally Unattended Installation (NUI) Assets on the United Kingdom Continental Shelf

## Safety Regulation Group

Flight Operations Inspectorate (Helicopters)

Mr Robert Paterson,  
Health, Safety and Employment Issues Director  
Oil and Gas UK Ltd  
3<sup>rd</sup> Floor,  
62 The Exchange  
Market Street  
Aberdeen  
AB11 5PJ

01 July 2011

Dear Robert,

### **Helideck Fire-fighting Provisions For Existing Normally Unattended Installation (NUI) Assets on the United Kingdom Continental Shelf**

#### 1. Background to the problem on existing NUI assets on the UKCS

Helidecks in the UK sector of the North Sea are regarded as unlicensed operating sites. Under Article 96 of the Air Navigation Order (ANO), offshore helicopter operators are required to satisfy themselves that each helideck they operate to is 'suitable for the purpose'. Helicopter operators discharge their duty of care through an inspection programme undertaken on their behalf by the Helideck Certification Agency (HCA), who assesses helidecks and related facilities against standards and best practice in UK Civil Aviation Publication CAP 437. In essence the HCA Certification process provides an assurance to the helicopter operators that they are fulfilling their duty of care under the ANO in only operating to helidecks that are suitable for the purpose.

Chapter 5 of CAP 437 contains detailed prescriptive requirements for Rescue and Fire-Fighting Services (RFFS) that are based on international standards and recommended practices in ICAO Annex 14 Volume II and the Heliport Manual (Doc. 9261). For manned installations and vessels and for new build NUIs, best practice requirements specify the delivery of foam (e.g. AFFF) at a high application rate and for an extended duration dispensed from either a Fixed Monitor System (FMS) or from a Deck Integrated Fire-Fighting System (DIFFS). For a NUI, which is unmanned for at least the first and last flight of the day, an automatically activated DIFFS ideally with a passive fire-retarding surface is preferred since this solution provides for automatic fire suppression and active intervention in the event of a major fire situation occurring during a take-off or landing where all trained fire crews are otherwise located in the helicopter.

Historically, for *existing* NUI facilities on the United Kingdom Continental Shelf (UKCS), CAP 437 'current best practice' has not been applied for RFFS and, until recently platform operators selected an RFFS on the basis of United Kingdom Offshore Operators Association (UKOOA) 'Guidelines for the Management of Offshore Helideck Operations' (Issue 5 - Feb 2005). The 'UKOOA Guidelines', which have been superseded by Oil and Gas UK 'Guidance for the Management of Aviation Operations (Issue 6, April 2011 - containing no specific reference to NUI RFFS), stipulated only minimal firefighting media requirements which were broadly equivalent to scales specified for a *low intensity H1 helicopter operation at a temporary onshore heliport* (reference source: CAP 789, Annex 3

to Chapter 21). It was not intended that such a minimal provision of primary fire-fighting media should be deemed acceptable for a permanent heliport operation, operating in a remote location in a hostile environment onto minimum size elevated landing areas, routinely using helicopters that are not only larger than the H1 category, but also carry more passengers and fuel compared to helicopters typically utilizing the CAP 789 low intensity requirements. Using the risk assessment elements promulgated in Section 1 of Appendix 1 to this letter, it is not justifiable to select such a reduced level of fire cover when all these factors are considered together.

It is evident that the current arrangements for RFFS on fixed NUI platforms on the UKCS are inadequate to address all likely, and reasonably foreseeable, fire situations that may be encountered during routine offshore helicopter operations. For this reason, taking account also of concerns raised by the offshore helicopter operators and the HCA, and with the support of the UK Health and Safety Executive, CAA has undertaken to conduct a review of the minimum scales of fire fighting media that would be appropriate for existing NUI assets operating on the UK Continental Shelf (for a full list of assets see Appendix 2). The following sections provide detailed outcomes of the review conducted with reference to other sources of UK best practice (including CAP 168 and CAP 789) and ICAO Annex 14 Volume II and the Heliport Manual (doc. 9261). Offshore duty holders and helicopter operators should be aware that the scales presented in this letter are considered to be *minimum requirements* for each specific category and, having determined the appropriate scale, agreed between the platform operator and helicopter operator, specific NUIs may still decide to select scales of media that are different from those prescribed, providing they are no lower than the appropriate baseline scale.

## 2. Determination of an appropriate Rescue and Fire Fighting Service (RFFS)

In the following sections a total of twenty seven separate options are provided for the consideration of primary media within nine tables promulgated on the basis of the following:

1. Whether the NUI operation is classed as "*Low Intensity*", "*Standard Intensity*" or "*Higher intensity*". (See definitions in Appendix 1, Section 2.)
2. Whether the largest helicopter operating to the NUI is classed within "*Helicopter Category H1 Large*", "*Helicopter Category H2 Medium*" or "*Helicopter Category H2 Large*". (See definitions in Appendix 1, Section 3.)
3. Whether the type of foam being discharged meets "*ICAO Performance Level B*", "*Performance Level B (Compressed Air Foam System)*" or "*ICAO Performance Level C*". (See discussion in Appendix 1, Section 4.)

In all cases the complementary media requirements for gaseous media and Dry Powder are identical, being based on CAP 437, Chapter 5, Section 4. Likewise the rescue equipment requirements are the same for every category, being based on CAP 437, Chapter 5, Section 7 (see also Appendix 1, Section 6). The requirements for Personal Protective Equipment (PPE) are specified in Appendix 1, Section 7.

In accordance with Appendix 1, Section 5, there is an inbuilt assumption that whatever method is used for discharging foam to the helideck, the response time objectives of CAP 437, Chapter 5, Section 2.2 are upheld; such that a delay of less than 15 seconds should be the operational objective measured from the time the system is activated to the actual production of foam at the required application rate. Depending on the overriding fire fighting objectives and assumptions (see Appendix 1, Section 5), the scales are presented to ensure the effective discharge of foam will last either for a minimum of 2 minutes or 5 minutes.

### 3. Determining the appropriate scale for each individual NUI operation

On the assumption the largest helicopter operating to a NUI and the Performance Level of selected foam are fully *objectively* derived, only the determination of categorisation of intensity, whether 'low', 'standard' or 'higher', has any degree of *subjectivity* attached. However, for each category of operation space for interpretation is very restricted since the threshold limits on helicopter and passenger movements, whether determined against a monthly or annual limit and the planned occupation of the NUI are pre-supposed in the definition. The scales presented for a low intensity operation, by taking account of the low number of annual movements, accept that the likelihood of a serious accident occurring with a serious fire ensuing are comparatively lower. When deciding whether an operation is classed as 'standard' or 'higher', there should be full recourse to the elements contained in the helicopter transport risk assessment (see Appendix 1, Section 1) to determine which of the remaining scales a specific NUI operation will fall into and whether in-fact there is a case for providing an RFFS which exceeds the baseline limit. There should also be a commitment to reviewing the elements of the helicopter transport risk assessment on an annual basis to ensure that the scales of RFFS provided for a NUI continue to be appropriate in accordance with the overall level of risk. Any conclusions arising from the risk assessment, to support a certain 'level' of operation, should be agreed with the helicopter operator, through the HCA.

### 4. Methods for primary foam delivery to the helideck

For a NUI, regardless of the policy on manning, there will always be occasions when a helicopter is required to approach to land or take-off from the installation when it is unattended. When in an 'unattended' mode this assumes there is nobody on the helideck to operate the foam dispensing equipment in the event of a crash occurring involving a fire situation. Therefore, it is necessary that any system of foam delivery is capable of discharging automatically, without the necessity for manual intervention. CAP 437, Chapter 5 discusses the main options for the effective discharge of foam to an offshore helicopter landing area and presents specifications for a Fixed Monitor System (FMS) in Section 2.3 and for a Deck Integrated Fire Fighting System (DIFFS) in Section 2.9. It is firstly essential for a NUI that where a DIFFS or an FMS are selected to discharge foam to the landing area they are able to be *immediately* and *automatically* activated in the event of a fire occurring. Likewise these systems should be able to deliver finished foam to any part of the helideck at or above the minimum application rate for the range of weather conditions prevalent for the UKCS. A DIFFS, consisting of a series of pop-up nozzles by design should more easily achieve the effective and even distribution of foam to all parts of the landing area because the pattern of 'pop-up' sources can be arranged over the whole landing area (note: individual pop-ups should be sited in such a way to allow unimpeded right of entry to all access platforms). However, experience from other offshore sectors in the North Sea operating automatic RFFS on NUIs, has highlighted also the possibility of a ring-main system (RMS) arrangement, where a series of nozzles are located equally-spaced right around the perimeter of the landing area, within prescribed height limits for the 210° sector and 1<sup>st</sup> segment limited obstacle sector, so that foam is discharged from all directions around the helideck. Any system selected should be automatically initiated but with a manual override function on the NUI and from an adjacent mother platform or from the beach. An FMS will need to have a built in capability to allow for self-oscillation of monitors.

Whatever method of foam delivery is determined, it is important that the equipment selected is low maintenance such that any checks prescribed by the manufacturer can ideally be contained within routine maintenance cycles for the platform. It should be the objective of platform operators to avoid having to make additional unscheduled visits to the platform simply to service firefighting equipment, which could have a detrimental effect on the overall risk profile for the platform. Experience suggests, for example, that selecting pre-mix sealed

foam systems, capable of discharging aspirated or non-aspirated foam will usually require less effort to maintain.

5. Which installations need to review their current RFFS provision?

Based on information provided by the HCA in interrogating the Helideck Limitations List (HLL), there are understood to be 116 NUIs operating within the UKCS. These installations are listed, by region, in Appendix 2. This list includes all NUIs regardless of their existing RFFS provision. Thus Appendix 2 may be assumed as the definitive list of installations that need to review their current RFFS provision. The list of 116 NUIs is understood to encompass the assets of approximately 20 offshore duty holders currently serviced by a range of helicopters from three offshore helicopter operators. It is important, before any rectification action is implemented, that the platform operator provides full movement /manning data to the helicopter operator to facilitate discussion and agree a methodology and programme for any upgrade of RFFS. Prior to implementation, it will be necessary for the HCA to endorse any action plan. HCA will wish to ensure that any rectification work, including the physical location of foam dispensing equipment, does not compromise CAP 437 obstruction criteria or invalidate any conditions of the current landing area certificate for the installation.

6. Scales of primary and secondary media for existing asset NUIs

**LARGE H1 RFFS Standard Intensity**

Extinguishing Agent Requirements

Foam Meeting Performance Level B			Foam Meeting Performance Level C			Complementary Agent		
Total foam solution (Litres)	Minimum discharge rate of foam (L/Min)	Minimum duration (Min)	Total foam solution (Litres)	Minimum discharge rate of foam (L/Min)	Minimum duration (Min)	Dry Chemical Powder (Kg)	And	Gaseous Agent (Kg)
900 (650)	450 (325)	2 (2)	600	300	2	45		18

Notes:

1. Complementary agents should be capable of discharge at an effective rate delivered from one or two extinguishers.
2. Halon extinguishing agents are no longer prescribed for new installations. Gaseous agents, including CO<sub>2</sub> have replaced them. Gaseous extinguishers should be provided with a suitable applicator for use on engine fires.
3. Dry Chemical Powder should be a foam compatible type capable of dealing with Class B fire (or liquid hydrocarbons).
4. Pre-mix foam systems should be fully automatic and be capable of activating instantaneously in the event of an impact of a helicopter on the helideck where fire results. The automatic system should dispense aspirated or non-aspirated foam in a jet or spray pattern.
5. Where a Compressed Air Foam System (CAFS) meeting Performance Level B is selected in lieu of standard foam, the capacity and application rate may be accordingly reduced. The minimum requirements for CAFS are shown within the bracketed values in the above table.

**LARGE H1 RFFS Low Intensity**

## Extinguishing Agent Requirements

Foam Meeting Performance Level B			Foam Meeting Performance Level C			Complementary Agent		
Total foam solution (Litres)	Minimum discharge rate of foam (L/Min)	Minimum duration (Min)	Total foam solution (Litres)	Minimum discharge rate of foam (L/Min)	Minimum duration (Min)	Dry Chemical Powder (Kg)	And	Gaseous Agent (Kg)
150	75	2	120	60	2	45		18

## Notes:

1. Complementary agents should be capable of discharge at an effective rate delivered from one or two extinguishers.
2. Halon extinguishing agents are no longer prescribed for new installations. Gaseous agents, including CO<sub>2</sub> have replaced them. Gaseous extinguishers should be provided with a suitable applicator for use on engine fires.
3. Dry Chemical Powder should be a foam compatible type capable of dealing with Class B fire (or liquid hydrocarbons).
4. Premix-foam units may be aspirated or non-aspirated but should be capable of delivering agent to the seat of the fire.
5. Where a Compressed Air Foam System (CAFS) meeting Performance Level B selected in lieu of standard foam, the capacity and application rate may be accordingly reduced. The minimum requirements for CAFS in this case are assumed to be equivalent to amounts specified for Performance Level C foams.

**LARGE H1 RFFS Higher Intensity**

## Extinguishing Agent Requirements

Foam Meeting Performance Level B			Foam Meeting Performance Level C			Complementary Agent		
Total foam solution (Litres)	Minimum discharge rate of foam (L/Min)	Minimum Duration (Min)	Total foam solution (Litres)	Minimum discharge rate of foam (L/Min)	Minimum duration (Min)	Dry Chemical Powder (Kg)	And	Gaseous Agent (Kg)
2250 (1625)	450 (325)	5 (5)	1500	300	5	45		18

## Notes:

1. Complementary agents should be capable of discharge at an effective rate delivered from one or two extinguishers.

2. Halon extinguishing agents are no longer prescribed for new installations. Gaseous agents, including CO<sub>2</sub> have replaced them. Gaseous extinguishers should be provided with a suitable applicator for use on engine fires.
3. Dry Chemical Powder should be a foam compatible type, capable of dealing with Class B fire (or liquid hydrocarbons).
4. Pre-mix foam systems should be fully automatic and be capable of activating instantaneously in the event of an impact of a helicopter on the helideck where fire results. The automatic system should dispense aspirated or non-aspirated foam in a jet or spray pattern.
5. The primary media levels specified for a higher intensity operation which is staffed for more than 50% of public transport helicopter movements, assumes a fire attack lasting approximately 5 minutes. It is acceptable, within the overall strategy, to employ at least one additional hand-controlled foam branch pipe for the delivery of aspirated foam, to any part on the landing area or its appendages, with a minimum discharge rate of 225 L/Min.
6. Where a Compressed Air Foam System (CAFS) meeting Performance Level B is selected in lieu of standard foam, the capacity and application rate may be accordingly reduced. The minimum requirements for CAFS are shown within the bracketed values in the above table.

### MEDIUM H2 RFFS Standard Intensity

#### Extinguishing Agent Requirements

Foam Meeting Performance Level B			Foam Meeting Performance Level C			Complementary Agent		
Total foam solution (Litres)	Minimum discharge rate of foam (L/Min)	Minimum duration (Min)	Total foam solution (Litres)	Minimum discharge rate of foam (L/Min)	Minimum duration (Min)	Dry Chemical Powder (Kg)	And	Gaseous Agent (Kg)
1200 (850)	600 (425)	2 (2)	800	400	2	45		18

#### Notes:

1. Complementary agents should be capable of discharge at an effective rate delivered from one or two extinguishers.
2. Halon extinguishing agents are no longer prescribed for new installations. Gaseous agents, including CO<sub>2</sub> have replaced them. Gaseous extinguishers should be provided with a suitable applicator for use on engine fires.
3. Dry Chemical Powder should be a foam compatible type capable of dealing with Class B fire (or liquid hydrocarbons).
4. Pre-mix foam systems should be fully automatic and be capable of activating instantaneously in the event of an impact of a helicopter on the helideck where fire results. The automatic system should dispense aspirated or non-aspirated foam in a jet or spray pattern.



5. Where a Compressed Air Foam System (CAFS) meeting Performance Level B is selected in lieu of standard foam, the capacity and application rate may be accordingly reduced. The minimum requirements for CAFS are shown within the bracketed values in the above table.

### MEDIUM H2 RFFS Low Intensity

#### Extinguishing Agent Requirements

Foam Meeting Performance Level B			Foam Meeting Performance Level C			Complementary Agent		
Total foam solution (Litres)	Minimum discharge rate of foam (L/Min)	Minimum duration (Min)	Total foam solution (Litres)	Minimum discharge rate of foam (L/Min)	Minimum duration (Min)	Dry Chemical Powder (Kg)	And	Gaseous Agent (Kg)
310	155	2	220	110	2	45		18

#### Notes:

1. Complementary agents should be capable of discharge at an effective rate delivered from one or two extinguishers.
2. Halon extinguishing agents are no longer prescribed for new installations. Gaseous agents, including CO<sub>2</sub> have replaced them. Gaseous extinguishers should be provided with a suitable applicator for use on engine fires.
3. Dry Chemical Powder should be a foam compatible type capable of dealing with Class B fire (or liquid hydrocarbons).
4. Premix-foam units may be aspirated or non-aspirated but should be capable of delivering agent to the seat of the fire.
5. Where a Compressed Air Foam System (CAFS) meeting Performance Level B is selected in lieu of standard foam, the capacity and application rate may be accordingly reduced. The minimum requirements for CAFS in this case are assumed to be equivalent to amounts specified for Performance Level C foams.

### MEDIUM H2 RFFS Higher Intensity

#### Extinguishing Agent Requirements

Foam Meeting Performance Level B			Foam Meeting Performance Level C			Complementary Agent		
Total foam discharge (Litres)	Minimum discharge rate of foam (L/Min)	Minimum duration (Min)	Total foam discharge (Litres)	Minimum discharge rate of foam (L/Min)	Minimum duration (Min)	Dry Chemical Powder (Kg)	And	Gaseous Agent (Kg)
3000 (2125)	600 (425)	5 (5)	2000	400	5	45		18

## Notes:

1. Complementary agents should be capable of discharge at an effective rate delivered from one or two extinguishers.
2. Halon extinguishing agents are no longer prescribed for new installations. Gaseous agents, including CO<sub>2</sub> have replaced them. Gaseous extinguishers should be provided with a suitable applicator for use on engine fires.
3. Dry Chemical Powder should be a foam compatible type, capable of dealing with Class B fire (or liquid hydrocarbons).
4. Pre-mix foam systems should be fully automatic and be capable of activating instantaneously in the event of an impact of a helicopter on the helideck where fire results. The automatic system should dispense aspirated or non-aspirated foam in a jet or spray pattern.
5. The primary media levels specified for a higher intensity operation which is staffed for more than 50% of public transport helicopter movements, assumes a fire attack lasting approximately 5 minutes. It is acceptable, within the overall strategy, to employ at least one additional hand-controlled foam branch pipe for the delivery of aspirated foam, to any part on the landing area or its appendages, with a minimum discharge rate of 225 L/Min.
6. Where a Compressed Air Foam System (CAFS) meeting Performance Level B is selected in lieu of standard foam, the capacity and application rate may be accordingly reduced. The minimum requirements for CAFS are shown within the bracketed values in the above table.

**LARGE H2 RFFS Standard Intensity**

## Extinguishing Agent Requirements

Foam Meeting Performance Level B			Foam Meeting Performance Level C			Complementary Agent		
Total foam discharge (Litres)	Minimum discharge rate of foam (L/Min)	Minimum discharge Duration (Min)	Total foam discharge (Litres)	Minimum discharge rate of foam (L/Min)	Minimum duration (Min)	Dry Chemical Powder (Kg)	And	Gaseous Agent (Kg)
1500 (1080)	750 (540)	2 (2)	1050	525	2	45		18

## Notes:

1. Complementary agents should be capable of discharge at an effective rate delivered from one or two extinguishers.
2. Halon extinguishing agents are no longer prescribed for new installations. Gaseous agents, including CO<sub>2</sub> have replaced them. Gaseous extinguishers should be provided with a suitable applicator for use on engine fires.
3. Dry Chemical Powder should be a foam compatible type capable of dealing with Class B fire (or liquid hydrocarbons).

4. Pre-mix foam systems should be fully automatic and be capable of activating instantaneously in the event of an impact of a helicopter on the helideck where fire results. The automatic system should dispense aspirated or non-aspirated foam in a jet or spray pattern.
5. Where a Compressed Air Foam System (CAFS) meeting Performance Level B is selected in lieu of standard foam, the capacity and application rate may be accordingly reduced. The minimum requirements for CAFS are shown within the bracketed values in the above table.

### LARGE H2 RFFS Low Intensity

#### Extinguishing Agent Requirements

Foam Meeting Performance Level B			Foam Meeting Performance Level C			Complementary Agent		
Total foam solution (Litres)	Minimum discharge rate of foam (L/Min)	Minimum Duration (Min)	Total foam solution (Litres)	Minimum discharge rate of foam (L/Min)	Minimum duration (Min)	Dry Chemical Powder (Kg)	And	Gaseous Agent (Kg)
350	175	2	250	125	2	45		18

#### Notes:

1. Complementary agents should be capable of discharge at an effective rate delivered from one or two extinguishers.
2. Halon extinguishing agents are no longer prescribed for new installations. Gaseous agents, including CO<sub>2</sub> have replaced them. Gaseous extinguishers should be provided with a suitable applicator for use on engine fires.
3. Dry Chemical Powder should be a foam compatible type capable of dealing with Class B fire (or liquid hydrocarbons).
4. Premix-foam units may be aspirated or non-aspirated but should be capable of delivering agent to the seat of the fire.
5. Where a Compressed Air Foam System (CAFS) meeting Performance Level B is selected in lieu of standard foam, the capacity and application rate may be accordingly reduced. The minimum requirements for CAFS in this case are assumed to be equivalent to amounts specified for Performance Level C foams.

### LARGE H2 RFFS Higher Intensity

#### Extinguishing Agent Requirements

Foam Meeting Performance Level B			Foam Meeting Performance Level C			Complementary Agent		
Total foam discharge (Litres)	Minimum discharge rate of foam (L/Min)	Minimum Duration (Min)	Total foam discharge (Litres)	Minimum discharge rate of foam (L/Min)	Minimum duration (Min)	Dry Chemical Powder (Kg)	And	Gaseous Agent (Kg)

3750	750	5	2625	525	5	45		18
(2700)	(540)	(5)						

## Notes:

1. Complementary agents should be capable of discharge at an effective rate delivered from one or two extinguishers.
2. Halon extinguishing agents are no longer prescribed for new installations. Gaseous agents, including CO<sub>2</sub> have replaced them. Gaseous extinguisher should be provided with a suitable applicator for use on engine fires.
3. Dry Chemical Powder should be a foam compatible type, capable of dealing with Class B fire (or liquid hydrocarbons).
4. Pre-mix foam systems should be fully automatic and be capable of activating instantaneously in the event of an impact of a helicopter on the helideck where fire results. The automatic system should dispense aspirated or non-aspirated foam in a jet or spray pattern.
5. The primary media levels specified for a higher intensity operation which is staffed for more than 50% of public transport helicopter movements, assumes a fire attack lasting approximately 5 minutes. It is acceptable, within the overall strategy, to employ at least one additional hand – controlled foam branch pipe for the delivery of aspirated foam, to any part on the landing area or its appendages, with a minimum discharge rate of 225 L/Min.
6. Where a Compressed Air Foam System (CAFS) meeting Performance Level B is selected in lieu of standard foam, the capacity and application rate may be accordingly reduced. The minimum requirements for CAFS are shown within the bracketed values in the above table.
7. Timescales for rectification action

NUIs projects that are classed as 'higher intensity' operations should be assigned the highest priority and any necessary upgrade of RFFS should be completed **within three years from the date of this letter**. For all other operations, with those classed as 'standard intensity' receiving priority over those classed as 'low intensity', rectification should be completed **within six years** with an absolute cut-off for compliance of **30 June 2017**.

8. Request to disseminate to industry asset duty holders

I would be grateful if you could disseminate this letter amongst your members. This letter is copied for information to the offshore helicopter operators, the Helideck Certification Agency and the Health and Safety Executive, Offshore Safety Division.

Yours sincerely,

**Kevin P Payne**  
**Flight Standards Officer**  
**Flight Operations Inspectorate (Helicopters)**

## **Appendix 1: Further explanatory guidance and background for definitions and interpretations disseminated in the main letter**

### **1. Elements to be considered for the helicopter transport risk analysis**

1. The number of planned helicopter movements and frequency of movements.
2. The number of passengers landing and taking off from the NUI – whether or not the particular NUI is the final planned outbound or inbound destination for passengers.
3. The types of helicopters utilised and specific hazards (e.g. construction, fuel load).
4. The characteristics of the helideck and platform general arrangement (e.g. helideck access).
5. The largest helicopter authorised to operate to the helideck.
6. The level of planned occupation of the NUI including the off-shift policy.
7. Whether the helideck is attended or unattended during helicopter movements.

### **2. Definitions for low, standard and higher intensity operations**

**Low intensity operations:** Low intensity operations are regarded as those installations where the planned number of annual public transport helicopter movements does not exceed 10 and/or where the annual number of passengers landing on and taking off from the installation does not exceed 50. For an installation to qualify as a low intensity operation there should be no planned off-shift stays.

**Standard intensity operations:** Standard intensity operations are regarded as those where the planned number of annual public transport helicopter movements and/or the annual number of passengers landing on and taking off from the installation exceed the threshold levels prescribed for low intensity operations but where the planned number of movements are not expected to exceed 10 public transport helicopter movements per month and/or the number of passengers landing on and taking off from the installation is not expected to exceed 50 per month. Within this category, helicopters may be used to support regular visits to the installation provided that no off-shift stays are planned.

**Higher intensity operations:** Higher intensity operations should include any installations where off-shift stays are planned regardless of the frequency or duration of stays. In addition where helicopter operations are engaged to support frequent visits to an installation, but with no planned off-shift stays, these should also be included within the minimum requirements prescribed for higher intensity operations if the number of public transport helicopter movements exceeds 10 per month and/or the number of passengers landing on and taking off from the installation exceeds 50 per month.

Notes: A movement is defined as one take-off *or* one landing. A helicopter landing or taking off with no passengers on board may be regarded as a non-public transport (positioning) flight.

Installations with planned off-shift stays should automatically consider at least the minimum requirements prescribed for higher intensity operations.

Passenger numbers should take account of all persons on board the helicopter, excluding aircrew, at the point of touchdown to land or on take-off from the installation.

With the acceptance of the helicopter operator figures for projected future helicopter movements and passenger numbers may be derived on the basis of data collected for an installation over the previous three year period provided there are no foreseeable changes in operating practices which might result in a significant increase in one or either assessment parameter determining threshold limits.

The helicopter operator should be consulted on any queries that may arise for an interpretation of frequency of visits.

### 3. Definitions and interpretations for re-defining Helicopter fire fighting categorisation

ICAO Annex 14 Volume II provides definitions for H1, H2 and H3 as follows:

**Helicopter Category H1:** A helicopter with an overall length up to but not including 15m.

**Helicopter Category H2:** A helicopter with an overall length from 15m up to but not including 24m.

**Helicopter Category H3:** A helicopter with an overall length from 24m up to but not including 35m.

Note: H3 may be discounted on the basis there are no H3 helicopters operating to NUIs on the UKCS.

For the purpose of calculating the critical area for helicopter fire fighting category H1, H2 and H3 for a heliport, the ICAO Heliport Manual applies critical area calculations based on average fuselage dimensions for each category (to form a rectangular area of protection around a generic helicopter). For helicopter operations to NUIs, nearly all the helicopters being operated have fuselage dimensions that are appreciably greater than the average fuselage dimensions assumed for each generic category. Therefore, to ensure the critical area calculation addresses the fuselage dimensions for a range of helicopters likely to operate to a NUI helideck, critical area assumptions have been determined using the 'worst case' helicopter type within a series of operating helicopters on the following basis:

**Helicopter Category H1 Large:** includes all Dauphin AS 365 variants.

**Helicopter Category H2 Medium:** includes all variants of the S76, **AW 139** and the EC 155.

**Helicopter Category H2 Large:** includes EC 175, AS 332 L1 and L2, EC 225, **S92**, S61 and Bell 214.

For category H2 medium, the [bold] AW 139 is determined to be the worst case helicopter with the largest dimensional combination of fuselage length x width (plus 4m) and for category H2 Large, the [bold] S92 is assumed to be the worst case helicopter. Where NUIs adopt levels in accordance with these helicopter definitions it may be automatically assumed that any other helicopters listed in the same category, or in a lower category (where applicable), are also authorised to use the helideck from the perspective of the adequacy of RFFS. However, no account is taken of further additional types which might be introduced to service NUI operations in the future.

### 4. Rationale for minimum application rates assumptions

According to ICAO Annex 14 Volume II and the Heliport Manual (Doc. 9261) any foam concentrate used for heliport fire fighting should at least meet ICAO Performance Level B (i.e. Performance Level A foams are not permitted). For Performance Level B foam the standard application rate is **5.5 (L/min)/m<sup>2</sup>** based on the assumed critical area (m<sup>2</sup>). This is

the minimum application rate applied throughout this document for 'standard' Performance Level B foam (e.g. AFFF, FFFP). Advancements in foam technologies mean that the aviation sector is now making increasing use of Compressed Air Foam Systems (CAFS). Due to the superior fire suppression qualities of CAFS, it has been demonstrated through comparative test programmes that where a Performance Level B Compressed Air Foam System is utilised, the minimum application rate of the foam may be reduced to no less than **4.0 (L/min)/m<sup>2</sup>**. In addition it is anticipated ICAO Annex 14 Volume I will in future sanction the use of Performance Level C foams for aircraft fire fighting. In a similar way that Performance Level B foam is more efficient than a Level A foam, which is reflected in a lower application rate requirement, so Level C foam is proven to be more effective than a comparative Level B foam. Consequently provision is made in the tables for the use of Performance Level C foam discharged with a minimum application rate of not less than **3.75 (L/min)/m<sup>2</sup>**. These developments effectively give offshore duty holders much more flexibility to select foam systems based on the performance of each type of foam on the understanding that the more effective the foam technology, the less overall foam solution will be required to achieve the same results. This flexibility is especially useful for platforms where additional topside weight and storage capability are most critical.

**NOTE - ICAO Level C Foam:** A new standard for fire fighting foam is currently proposed and proceeding through the International Civil Aviation Organisation (ICAO) to be published in Annex 14 (Volume I) to the Convention on International Civil Aviation. The expected date for applicability of this amendment is 15 November 2012. The standard will require an improvement in fire fighting performance and foam manufacturers will be working to develop foams to meet this new standard. As with any product with an environmental impact, a balance will need to be made between safety, cost and the effects on the environment.

#### 5. Rationale for response time objective and discharge duration requirements

It is proposed that for an installation with RFFS which is unattended for at-least 50% of the time during public transport helicopter movements, a 2-minute minimum discharge capability is permitted. This assumes the automatic application of primary media at the required rate within 15 seconds of an accident occurring with the objective that any fire should be brought "under control" within 1-minute from commencing the discharge of primary foam media, thereby allowing the occupants of the helicopter, during a survivable accident, the opportunity to escape from the helicopter and clear the helideck environs, with the option for abandoning the platform if necessary.

For a platform to be classed as a higher intensity operation there is a good likelihood that the RFFS will be attended for more than 50% of public transport helicopter movements, such that there is a reasonable expectation that trained fire fighters will be present to tackle any fire scenario that might be expected to occur on the helideck including a helicopter crash with fire. In this case, having an additional 3 minutes of media discharge (5 minutes instead of 2 minutes), there is opportunity for a prolonged manual intervention to confront a fire situation and, having controlled the fire with the objective of saving lives, to ensure that the fire is completely extinguished, likely with media in hand to provide further post fire protection. In consideration of these additional objectives, where the discharge duration for the primary extinguishing agent for a higher intensity operation is increased from 2 to 5 minutes, it is acceptable that some of the additional media could be delivered from one or two hand-controlled foam branch pipes to allow delivery of foam to areas which might otherwise be inaccessible to fixed systems – see main letter and section entitled "Methods of foam delivery to the helideck".

For platforms classed as Low Intensity Operations the provision for an automated means of foam delivery system may be waived providing the Platform Safety Case records and justifies the non-availability of an automated fire-fighting protection system in the event of an accident occurring, which results in a major fire ensuing during a landing or take-off *when the platform is unattended*. During times when the platform is *attended* trained fire

and rescue crews should have at their disposal appropriate equipment including primary and secondary media for the purpose of saving life (in the event of an accident occurring) and/or for mopping up incidents involving minor fires (e.g. an engine fire). The level of media prescribed is not intended to provide for an extended and sustained attack on a major helicopter incident with fire.

#### 6. Rescue equipment

Rescue equipment should be provided in accordance with CAP 437, Chapter 5, Section 7 and should be provided for all NUI assets regardless of their classification.

#### 7. Personal Protective Equipment (PPE)

All responding RFF personnel should be provided with appropriate PPE to allow them to carry out their duties in an effective manner. Sufficient personnel to operate the RFF equipment effectively, when an installation is attended, should be dressed in suitable protective clothing.

For the selection of appropriate PPE, account should be taken of the HSE Personal Protective Equipment at Work Regulations (PPEWR) and the Provision and Use of Work Equipment Regulations (PUWER) which require equipment to be suitable and safe for intended use, maintained in a safe condition and, where appropriate, inspected to ensure it remains fit for purpose. In addition equipment should only be used by personnel who have received adequate information, instruction and training. PPE should be accompanied by suitable safety measures e.g. protective devices, markings and warnings. A responsible person should be appointed to ensure all PPE is installed, stored, checked and maintained in accordance with manufacturers' instruction.

Appropriate PPE should be determined through a process of risk assessment acceptable to the HCA and the offshore helicopter operators.



**Appendix 2: Normally Unattended Installations – list of existing NUI assets on the UKCS by region, requiring a review of Rescue and Fire Fighting**

**Northern North Sea (10)**

Beatrice B	Galahad	Shell B
Beatrice C	Galleon PG	Shell BT
Beryl SPM 2	Galleon PN	Shell C
Beryl SPM 3	Ganymede	Shell D
BP Unity	Garrow	Shell E
Erskine	Grove	Shell F
Franklin	Guinevere	Shell Lemn G
Goldeneye	Hewett 48/29B	South Valiant
Jade	Hewett 48/29C	Tethys
Mungo	Hewett 48/29Q	Trent
	Hewett 52/5A	Tyne

**UK West Coast (10)**

Calder	Hoton	Vampire
DP-3	Hyde	Vanguard QD
DP -4	Inde 18A	Victor JD
DP-6	Inde 18B	Viking AR
DP-8	Inde 23C	Vicking CD
DPPA	Inde 23D	Viking DD
Hamilton	Kelvin	Viking ED
Hamilton North	Ketch	Viking GD
Lennox	Kilmar	Viking HD
Millom West	Lancelot	Viking KD

**Southern North Sea (96)**

23E	Leman 27B	Viking LD
49-30A (Davy)	Leman 27C	Viscount
Amethyst A1D	Leman 27D	Vulcan 2 UR
Amethyst A2D	Leman 27E	Vulcan RD
Amethyst B1D	Leman 27F	Waveney
Amethyst C1D	Leman 27G	Wenlock
Anglia A	Leman 27H	West Sole B
Audrey WD	Leman 27J	West Sole C
	Malory	Windemere
	Markham ST-1	
	Mimas	
	Minerva	
	Munro	

**Total No.NUIs = 116**

Camelot A (subsequently notified)

Audrey XW	Neptune
Babbage	North Valiant SP
Barque PB	Pickerill A
Barque PL	Pickerill B
Boulton BM	Ravenspurn North ST2
Caister	Ravenspurn North ST3
Carrack QA	Ravenspurn RA
Cavendish	Ravenspurn RB
Chiswick	Ravenspurn RC
Covette	Saturn
Europa	Schooner
Excalibur	Sean R

INTENTIONALLY LEFT BLANK

# Appendix E Additional Guidance Relating to the Provision of Meteorological Information from Offshore Installations

## 1 Introduction

- 1.1 This Appendix provides additional guidance on the provision of meteorological information from offshore installations, which is detailed in Chapter 6, paragraph 4.
- 1.2 The provision of meteorological information for the safety, efficiency and regulation of international air navigation is subject to international standards and recommended practices described in Annex 3 to the Chicago Convention published by ICAO. Requirements for observer training and observing accuracy are set out by the United Nation's World Meteorological Organization (WMO).
- 1.3 *CAP 746 Meteorological Observations at Aerodromes* provides the policy and guidance related to the provision of meteorological information at aerodromes in the UK. To ensure compliance with these requirements, and to standardise the provision of meteorological information provided, where practicable CAP 746 applies. Specific exceptions are detailed in paragraph 2 below.

## 2 Contents and Standardisation of the Weather Reports Issued by Each Offshore Installation

### 2.1 Wind

To be reported as per CAP 746 (Chapter 4, paragraph 3).

### 2.2 Visibility

To be reported in metres, as per CAP 746 (Chapter 4, paragraph 5). The visibility reported is the minimum visibility. Visibilities greater than 10 km should be reported as 9999.

### 2.3 Lightning

When lightning is observed, it should be included in the report.

### 2.4 Present Weather

- 2.4.1 Only the following weather phenomena are required to be reported:

- Thunderstorm (No Precipitation)
- Thunderstorm with Rain
- Thunderstorm with Rain and Snow
- Thunderstorm with Snow
- Thunderstorm with Hail
- Thunderstorm with Heavy Rain
- Thunderstorm with Heavy Rain and Snow
- Thunderstorm with Heavy Snow
- Thunderstorm with Heavy Hail
- Thunderstorm in the Vicinity

Drizzle  
Heavy Drizzle  
Rain  
Heavy Rain  
Rain and Drizzle  
Heavy Rain and Drizzle

Freezing Rain  
Heavy Freezing Rain  
Freezing Drizzle  
Heavy Freezing Drizzle  
Snow Grains  
Snow  
Heavy Snow  
Rain and Snow  
Heavy Rain and Snow  
Ice Pellets

Rain Shower  
Heavy Rain Shower  
Rain and Snow Shower  
Heavy Rain and Snow Shower  
Snow Shower  
Heavy Snow Shower  
Hail Shower  
Heavy Hail Shower  
Shower in the Vicinity

Fog  
Freezing Fog  
Fog Patches  
Partial Fog  
Shallow Fog  
Fog in the Vicinity  
Haze  
Mist  
Smoke  
Dust  
Sea Spray

Squall  
Funnel Cloud  
Volcanic Ash  
Blowing Sand  
Sandstorm

- NOTES:**
1. Guidance on the reporting of these present weather phenomena is as per CAP 746 (Chapter 4, paragraph 7).
  2. No coding is required since the report is to be written in plain language.
  3. If none of the above is observed then the entry for Present Weather will be Nil.
  4. Where appropriate up to three of the above phenomena may be reported.

## 2.4.2 Reporting of Fog

Due to the small area that a helideck covers, compared to an aerodrome, the following guidance has been provided for the reporting of fog. As each installation has a 500 m exclusion zone it has been decided to use this for the reporting of fog. If there is fog (either within or outside the 500 m zone) and the visibility is <1,000 m in all directions then Fog (or Freezing Fog) should be reported as the Present Weather. If there is fog within the 500 m zone and the visibility is <1,000 m in only some directions then Partial Fog (fog bank) or Fog Patches should be reported as the Present Weather. Shallow Fog will be reported as the Present Weather if it is observed, whether patchy or as a continuous layer, within the 500 m zone below helideck level (the visibility above the Shallow Fog will be 1,000 m or more). Where there is no fog within the 500 m zone but fog can be seen within 8 km, the Present Weather should be reported as Fog in the Vicinity with a note in the remarks section indicating Shallow Fog, Partial Fog (fog bank) or Fog Patches. Additionally the remarks section could also include a direction in which the fog is seen, e.g. Partial Fog to East.

## 2.5 Cloud

### 2.5.1 Cloud amount is reported as:

- Few (FEW);
- Scattered (SCT);
- Broken (BKN); and
- Overcast (OVC);

as per CAP 746 (Chapter 4, paragraph 8). Sky Obscured (VV///) and No Significant Cloud (NSC) should also be reported.

### 2.5.2 Cumulonimbus (CB) or Towering Cumulus (TCU) should be added to the report when present.

### 2.5.3 Cloud heights are to be reported in plain language in feet AMSL, rounded down to the nearest 100 ft. There is no requirement to report cloud above 5,000 ft unless CB or TCU is present.

### 2.5.4 A maximum of four cloud groups can be reported.

## 2.6 CAVOK (Cloud and Visibility OK)

To be reported as per CAP 746 (Chapter 4, paragraph 4). When appropriate to do so, CAVOK should be reported as Present Weather.

## 2.7 Air Temperature and Dew Point

To be reported as per CAP 746 (Chapter 4, paragraph 9).

## 2.8 QNH and QFE (Atmospheric Pressure)

To be reported as per CAP 746 (Chapter 4, paragraph 10).

## 2.9 Significant Wave Height

Where sensors are deployed for the measurement of Significant Wave Height the information can be included in the report. The Wave Height should be reported to one decimal place, e.g. 7.6 m.

## 2.10 Pitch, Roll, Helideck Inclination and Significant Heave Rate

Current good practice is provided in CAP 437, Chapter 6, paragraph 3.

## 2.11 Remarks

This part of the form can be used to report additional Meteorological-related information that may assist the helicopter crew, e.g. Lightning seen at 12.30, Fog bank to SW, or Heavy Rain shower at 16.20. When a sensor is unavailable and an estimate has been made of the conditions, a note should be recorded in the Remarks section.

2.12 **Missing or Unavailable Information**

Exceptionally, when a sensor is unserviceable and the contingency device is not able to be accessed, or is also unserviceable, the report should be annotated with N/A indicating that the information is not available.

**3 Example Offshore Report**

3.1 A pre-flight weather report form template is given below that should be used to supply the relevant information. An example report is also provided (see Figure 2).

Location	<input style="width: 95%;" type="text"/>	Vessel Heading	<input style="width: 95%;" type="text"/> degrees
Lat	<input style="width: 25px;" type="text"/> <input style="width: 25px;" type="text"/> <input style="width: 25px;" type="text"/> <input style="width: 25px;" type="text"/>	Long	<input style="width: 25px;" type="text"/> <input style="width: 25px;" type="text"/> <input style="width: 25px;" type="text"/> <input style="width: 25px;" type="text"/>
Date	<input style="width: 150px;" type="text"/>	Time	<input style="width: 100px;" type="text"/> UTC
Wind	<input style="width: 150px;" type="text"/> degrees	Speed	<input style="width: 80px;" type="text"/> knots
		Gust	<input style="width: 80px;" type="text"/> knots
Visibility	<input style="width: 300px;" type="text"/> metres	Lightning Present	<input style="width: 100px;" type="text"/> Yes / No
Present Weather	<input style="width: 430px;" type="text"/>		
Cloud amount	<input style="width: 150px;" type="text"/>	Cloud Height	<input style="width: 100px;" type="text"/> feet
Cloud amount	<input style="width: 150px;" type="text"/>	Cloud Height	<input style="width: 100px;" type="text"/> feet
Cloud amount	<input style="width: 150px;" type="text"/>	Cloud Height	<input style="width: 100px;" type="text"/> feet
Cloud amount	<input style="width: 150px;" type="text"/>	Cloud Height	<input style="width: 100px;" type="text"/> feet
Air Temperature	<input style="width: 150px;" type="text"/> °C	Dew Point	<input style="width: 100px;" type="text"/> °C
Pressure QNH	<input style="width: 150px;" type="text"/> hPa	QFE	<input style="width: 100px;" type="text"/> hPa
Significant Wave Height	<input style="width: 150px;" type="text"/> metres	Significant Heave Rate	<input style="width: 100px;" type="text"/> metres/sec
Pitch	<input style="width: 100px;" type="text"/> degrees up <input style="width: 100px;" type="text"/> degrees down	Roll	<input style="width: 100px;" type="text"/> degrees left <input style="width: 100px;" type="text"/> degrees right
		Helideck Inclination	<input style="width: 100px;" type="text"/> degrees
Remarks	<input style="width: 450px;" type="text"/>		

**Figure 1** Offshore Weather Report Form – Template

Location	METOCEAN1			Vessel Heading	319 degrees				
Lat	N	57	01	56	Long	E	01	57	18
Date	16/04/2012			Time	12:50 UTC				
Wind	230 200V270 degrees			Speed	18 knots		Gust	32 knots	
Visibility	2000 metres			Lightning Present	Yes				
Present Weather	Rain Shower / Thunderstorms in the Vicinity								
Cloud amount	FEW			Cloud Height	800 feet				
Cloud amount	SCT			Cloud Height	1200 feet				
Cloud amount	BKN			Cloud Height	3000 feet				
Cloud amount	BKN CB			Cloud Height	6000 feet				
Air Temperature	18 °C			Dew Point	12 °C				
Pressure QNH	1009 hPa			QFE	1004 hPa				
Significant Wave Height	3.6 metres			Significant Heave Rate	1.1 metres/sec				
Pitch	2.1 degrees up 1.3 degrees down		Roll	1.2 degrees left 1.3 degrees right		Helideck Inclination	2.8 degrees		
Remarks	Hail Shower at 12:30.								

**Figure 2** Offshore Weather Report – Example

## 4 Definition of an Offshore Meteorological Observer

- 4.1 **Offshore Meteorological Observer:** any competent person who makes a weather observation or who updates a weather observation which is provided either as a Pre-Flight Weather Report or as a Radio Message to a helicopter en route to a fixed or floating offshore facility. Such personnel should be trained and qualified as a Meteorological Observer for Offshore Helicopter Operations.
- 4.2 Master Mariners who have been issued with a Marine Coastguard Agency (MCA) Certificate Officer of the Watch (OOW) or equivalent qualification and are regularly providing WMO-compliant ship meteorological observations may be considered competent to provide weather observations for offshore helicopter operations. However, Master Mariners are recommended to become certificated Offshore Met Observers in order to ensure that the information being provided specifically to helicopter operators is to the standards required since there are a number of important differences compared to WMO ship observations.

## 5 Applicability of Meteorological Equipment to Helideck Categories

5.1 The following categories of helideck should meet the requirements for Meteorological instrumentation given in CAP 437:

- fixed installations (HLL Code A);
- semi-submersible, e.g. semi-submersible crane and lay barges, purpose-built monohull Floating Storage Units (FSUs) and production vessels (HLL Code 1); and
- large ships, e.g. drill ships, Floating Production Storage and Offloading units (FPSOs) whether purpose-built or converted oil tankers, non-semi-submersible and lay barges and self-elevating rigs on the move (HLL Code 1).

**NOTE:** Due to less frequent helicopter operations, the weather reports for smaller ships, e.g. Diving Support Vessels (DSVs), support and seismic vessels and tankers (HLL Codes 2 and 3), are required to contain only wind, pressure, air temperature and dew point temperature information. For the purposes of this note, 'less frequent helicopter operations' may be interpreted to mean 'not exceeding 12 landings per year'. Similarly, where weather information is being provided by NUIs, the weather report should include (as a minimum) wind, pressure, air temperature and dew point temperature information. Following notification to the Southern Aviation Safety Forum (SASF), only specific NUIs in the southern North Sea are required to provide the information noted above.

## 6 Design, Siting and Back-up Requirements for Meteorological Equipment Installed in Offshore Installations

### 6.1 Wind Speed and Direction

(See CAP 746, Chapter 7, paragraph 3.)

#### 6.1.1 Performance

- a) The wind measuring equipment should provide an accurate and representative measurement of wind speed and direction.
- b) Wind direction data should be oriented with respect to True North.
- c) The wind speed measurement should be to an accuracy of within  $\pm 1$  kt, or  $\pm 10\%$  for wind speeds in excess of 10 kt, of the actual wind speed (whichever is the greater), over the following ranges:

**Table 1** Tolerance Values of Sensors and Equipment – Wind Speed

Variable	In-Tolerance Operating Range	Recoverable Range
Wind speed	0 to 100 kt	0 to 130 kt

- d) With wind speeds in excess of 2 kt, the wind direction system should be capable of producing an overall accuracy better than  $\pm 10^\circ$ . The sensor should be sampled at a minimum rate of four times every second. Where wind systems measure the gust, the equipment should calculate the three-second gust as a rolling average of the wind speed samples.
- e) The equipment should be capable of producing two- and ten-minute rolling averages of the wind speed and direction. The algorithms used for the production of such averages should be defined. The average direction displayed should take regard of the numerical discontinuity at North.



### 6.1.2 Back-up

A hand-held anemometer may be used as a back-up; any readings that are taken should be taken from the centre of the helideck. The pilot should be advised that a hand-held anemometer has been used to estimate the wind speed and a remark should be added to the offshore weather report form.

### 6.1.3 Siting

(This is detailed in Chapter 6, paragraph 4.2.1, Assessment of Wind Speed and Direction.)

The aim is to site the wind sensor in such a position to capture the undisturbed flow. It is recommended that the wind sensor be mounted at the highest practical point, e.g. on the drilling derrick or the telecommunications mast. However, it should be noted that regular servicing is required and for that reason the flare stack should not be used. If no suitable mast is available then a specific wind sensor mast should be erected; however, this should not interfere with helicopter operations. If the location is obstructed then a second anemometer should be fitted to cover any compass point that may be obstructed from the primary wind sensor. The height AMSL for each anemometer should be recorded. Ultrasonic sensors should not be fitted in close proximity to electromagnetic sources such as radar transmitters.

## 6.2 Temperature

(See CAP 746, Chapter 7, paragraph 5.)

### 6.2.1 Performance

- a) The equipment should be capable of measurement to an accuracy better than  $\pm 1.0^{\circ}\text{C}$  for air temperature and dew point, over the following range:

**Table 2** Tolerance Values of Sensors and Equipment – Temperature and Humidity

Variable	In-Tolerance Operating Range	Recoverable Range
Temperature	$-25^{\circ}\text{C}$ to $+50^{\circ}\text{C}$	$-30^{\circ}\text{C}$ to $+70^{\circ}\text{C}$
Humidity	5 to 100% Relative Humidity condensing	0 to 100% Relative Humidity condensing

**NOTE:** Dew point should be displayed for temperatures below zero; frost point should not be displayed.

- b) Temperature and dew point measurements should be measured to a resolution of  $0.1^{\circ}\text{C}$ . Electronic sensors should be sampled at a minimum rate of once per minute.

### 6.2.2 Back-up

Alternative sensors should be provided with an accuracy better than  $\pm 1.0^{\circ}\text{C}$  for air temperature and dew point measurement. These sensors should be able to be easily read by the observer in the event of a failure of the main sensor.

### 6.2.3 Siting

Temperature and humidity sensors should be exposed in an instrument housing (e.g. Stevenson Screen), which provides protection from atmospheric radiation and water droplets as either precipitation or fog. The sensors should be located in an area that is representative of the air around the landing area and away from exhausts of building heating and equipment cooling systems. For this reason it is recommended that the

sensors are located as close to the helideck as possible. The most common area is directly below the helideck, since this provides mechanical protection to the Screen itself. The site should be free of obstructions and away from areas where air may be stagnant, e.g. near blast walls or close to the superstructure of the platform.

### 6.3 Pressure

(See CAP 746, Chapter 7, paragraph 4.)

#### 6.3.1 Performance

- a) No observing system that determines pressure automatically should be dependent upon a single sensor for pressure measurement. A minimum of two co-located sensors should be used. The pressure sensors should be accurate to within 0.5 hectoPascals of each other.

**NOTE:** In the event of failure of one or more individual pressure sensors, or where pressure sensors are not accurate to within 0.5 hectoPascals of each other, the system should not provide any pressure reading to the user.

- b) Automatic sensors should be sampled at a minimum rate of once per minute in order to detect significant changes.
- c) The measurement system should provide a pressure reading to an accuracy of  $\pm 0.5$  hectoPascals or better over the following range:

**Table 3** Tolerance Values of Sensors and Equipment – Pressure

Variable	In-Tolerance Operating Range	Recoverable Range
Pressure	900 to 1050 hPa	850 to 1200 hPa

- d) The sensor should provide an output with a minimum system resolution of 0.1 hPa.

#### 6.3.2 Back-up

- a) Suitable back-up instrumentation includes:
- precision aneroid barometers; and
  - digital precision pressure indicators.
- b) Where the pressure is not being determined automatically the observer should ensure that the appropriate height and temperature corrections are applied.
- c) Manual atmospheric pressure measuring equipment (as noted above) should be checked daily for signs of sensor drift by comparison with other pressure instrumentation located on the offshore installation. CAP 746, Appendix D, Daily Atmospheric Pressure Equipment QNH Check, provides an example of the type of form that may be used to assist in the monitoring process.

#### 6.3.3 Siting

- a) Pressure readings are of critical importance to aviation safety and operations. Great care should be taken to ensure that pressure sensor siting is suitable and provides accurate data.
- b) Pressure sensors can accurately measure atmospheric pressure and will provide representative data for the weather report provided the sensors are correctly located and maintained.
- c) The equipment should be installed so that the sensor measurements are suitable for the operational purpose and free of external influences.

- d) If the equipment is not installed at the same level as the notified helideck elevation, it should be given a correction factor in order to produce values with respect to the reference point. For QNH this is the height above sea level and for QFE the height of helideck above sea level.
- e) Where required, the manufacturer's recommended venting method should be employed to isolate the sensor from the internal environment. The pressure sensor should be installed in a safe area, typically the Telecommunications Room, and in close proximity to the Meteorological processing system. In most cases, internal venting of the pressure sensors will be satisfactory. However, if it is determined that internal venting may affect the altimeter setting value to the extent that it is no longer within the accuracy limits given below, outside venting should be used. When the pressure sensor is vented to the outside a vent header (water trap) should be used. The venting interface is designed to avoid and dampen pressure variations and oscillations due to 'pumping' or 'breathing' of the pressure sensor venting equipment.
- f) The sensors should also be located in an area free of jarring, vibration and rapid temperature fluctuations (i.e. avoid locations exposed to direct sunlight, draughts from open windows, and locations in the direct path of air currents from heating or cooling systems). Regular inspections of the vent header should be carried out to ensure that the header does not become obstructed by dust etc.

## 6.4 Visibility

(See CAP 746, Chapter 7, paragraph 7.)

### 6.4.1 Performance

- a) The performance of the measuring system is limited by the range and field of view of the sensor. The equipment should be capable of measurement to the following accuracy limits to a range of 15 km:

Range	Accuracy
Up to and including 550 m	Visibility $\pm 50$ m
Between 600 m and 1,500 m	Visibility $\pm 10\%$
Between 1,500 m and 15 km	Visibility $\pm 20\%$

- b) The visibility measuring system should measure to a resolution of 50 m.
- c) The sensor(s) should be sampled at a minimum rate of once per minute. An averaging period of 10 minutes for weather reports should be used; however, where a marked discontinuity occurs only those values after the discontinuity should be used for obtaining mean values.

**NOTE:** A marked discontinuity occurs when there is an abrupt and sustained change in visibility, lasting at least two minutes, which reaches or passes through the following ranges:

10 km or more
5,000 m to 9 km
3,000 m to 4,900 m
2,000 m to 2,900 m
1,500 m to 1,900 m
800 m to 1,400 m
750 m or less

#### 6.4.2 Back-up

The accredited observer should assess the visibility by eye. Where possible, visibility reference points should be provided. Structures illuminated at night should be indicated. When the visibility has been assessed by eye a remark should be included in the weather report form.

#### 6.4.3 Siting

The sensor should be positioned in accordance with the manufacturer's specifications and is normally mounted on a mast. The visibility sensor transmits an infrared beam that measures the refraction caused by suspended particles that obstruct visibility, i.e. mist, fog, haze, dust and smoke. For this reason it is important to avoid any interference such as flares, smoke vents, etc. Areas of the installation that are used for wash-down or are susceptible to sea spray should be avoided. The sensor should be located as far away as practicable from other light sources that might affect the measurement, including direct sunlight or spotlights etc., as these will cause interference. These sensors are only suitable for safe areas. These sensors require routine maintenance, calibration and cleaning; hence they should be positioned in a location that is easily accessible.

### 6.5 Present Weather Sensor

(See CAP 746, Chapter 7, paragraph 8.)

#### 6.5.1 Performance

- a) The sensor should be capable of detecting a precipitation rate greater than or equal to 0.05 mm per hour, within 10 minutes of the precipitation commencing.
- b) Where intensity is measured, the sensor should be capable of measuring the range of intensity from 0.00 mm per hour to 100 mm per hour and resolve this to the following resolutions:

Range	Resolution
0-10 mm per hour	0.1 mm
10.5 to 50 mm per hour	0.5 mm
51 to 100 mm per hour	1 mm

- c) The sensor should be accurate to within  $\pm 30\%$  in the range 0.5 to 20 mm per hour.
- d) Where the sensor is capable of doing so, it should discriminate between liquid precipitation and frozen precipitation.

#### 6.5.2 Back-up

The accredited observer should assess the present weather manually, assisted by reference material as appropriate. When the present weather has been assessed manually a remark should be included in the offshore weather report form.

#### 6.5.3 Siting

The sensor should be positioned in accordance with the manufacturer's specifications. The sensor should be located as far away as practicable from the shielding effects of obstacles and structures.

## 6.6 Cloud

(See CAP 746, Chapter 7, paragraph 6.)

### 6.6.1 Performance

- a) The performance of the cloud base recorder is limited by the view of the sensor. The equipment should be capable of measurement to the following accuracy limits, from the surface up to 5,000 ft above ground level:

Range	Accuracy
Up to and including 300 ft	Cloud height $\pm 30$ ft
Above 300 ft	Cloud height $\pm 10\%$

- b) The cloud base recorder should measure to a resolution of 100 ft.
- c) The sensor(s) should be sampled at a minimum rate of once per minute.
- d) Where appropriate software is utilised, cloud base detection systems may also provide an indication of the cloud amount. A cloud cover algorithm unit calculates the cloud amounts and the heights of different cloud layers, in order to construct an approximation of the entire sky. Such an approximation is limited by the detection system's coverage of the sky and should not be used in the weather report unless validated by the accredited observer.

### 6.6.2 Back-up

The accredited observer should assess the cloud by eye and estimate the height, assisted by reference material where appropriate. It should be noted that human estimates of cloud height without reference to any form of measuring equipment (particularly at night) may not meet the accuracy requirements stated above, so it is essential that when the cloud height has been assessed manually a remark is included in the offshore weather report form.

### 6.6.3 Siting

The sensor should be positioned in accordance with the manufacturer's specifications and is normally mounted on a platform or pedestal. The sensor should be located as far away as practicable from other light sources or reflections that might affect the measurement. Most ceilometers are fitted with blowers that prevent precipitation from settling on the lens; however, it is recommended that the sensor is installed in an area free of sea spray and away from any areas that are used routinely for wash-down. The sensor should have a clear view of the sky, uninterrupted by cranes or other structures that may obscure the sensor's view. The height of the sensor above sea level should be noted to ensure that the necessary correction is applied to all readings. These types of sensors are only suitable for installation in safe areas and should not be installed near to radars or other radio transmitters.

## 7 Calibration, Maintenance and Servicing Periods

- 7.1 All sensors should be serviced by an engineer on at least an annual basis. Calibration should take place according to the instrument manufacturer's recommendation. Cleaning and routine maintenance should take place according to the instrument manufacturer's guidance; however, due to the harsh offshore environment, cleaning routines may have to be increased in certain conditions.

INTENTIONALLY LEFT BLANK

# Appendix F Procedure for Authorising Offshore Helicopter Landing Areas

## Safety Regulation Group

Flight Ops Inspectorate (Helicopters)

October 2011

Dear Sirs

### **PROCEDURE FOR AUTHORISING OFFSHORE HELICOPTER LANDING AREAS**

This letter updates the legal requirements and related industry procedure for the authorisation of offshore helicopter landing areas on installations and vessels for the worldwide use by helicopters registered in the United Kingdom.

Article 96 of the Air Navigation Order (ANO) 2009 requires a public transport helicopter operator to reasonably satisfy himself that every place he intends to take off or land is suitable for purpose.

A UK registered helicopter, therefore, shall not operate to an offshore helicopter landing area unless the operator has satisfied itself that the helicopter landing area is suitable for purpose and that it is properly described in the helicopter operator's Operations Manual.

CAP 437 gives guidance on standards for the arrangements that the CAA expects an operator to have in place in order to discharge this responsibility under article 96. The Helideck Certification Agency (HCA) procedure is established through a memorandum of understanding to withdraw helicopter landing area certification on behalf of the four offshore helicopter operators - Bristow Helicopters Ltd, Bond Offshore, CHC Scotia and British International Helicopters - to enable each to discharge its responsibilities under the ANO.

Article 12 of the ANO 2009 provides that to hold an Air Operator's Certificate (AOC) an operator must satisfy the CAA that amongst other things its equipment, organisation and other arrangements are such that it is able to secure the safe operation of aircraft.

When looking at a particular operator, the CAA will therefore have regard to its 'other arrangements'. These arrangements include the manner in which the operator discharges its duty under article 96, and the CAA for the grant or ongoing assessment of an AOC will audit the helicopter operators' application of the process on which the operator relies. As part of such an audit the CAA will periodically audit the processes and procedures of the HCA, in acting in the role of a sub-contractor to the helicopter operators providing their services to AOC holders for the purpose of authorising offshore helicopter landing areas. As part of such an audit, the CAA will review the HCA procedures and processes and may accompany an operator when the operator undertakes an audit of the HCA procedures or inspects an offshore helicopter landing area.

The legal acceptance for the safety of landing sites rests with the helicopter operator.

Yours faithfully

Captain C Armstrong

**Manager Flight Operations Inspectorate (Helicopters)**

INTENTIONALLY LEFT BLANK



# Appendix G Guidance for Helideck Floodlighting Systems

## 1 Introduction

- 1.1 Chapter 4, paragraph 3 sets out the best practice requirements for helideck lighting systems consisting of green perimeter lighting, a lit TD/PM Circle and a lit heliport identification 'H' marking. The statement is made within this paragraph that reliance on helideck floodlighting as a provision of primary visual cueing is no longer supported. However, the CAA has no objection to systems conforming to the good practice guidance contained in this Appendix being retained as a back-up for the Circle and 'H' lighting. Where required, floodlights may also be used for lighting the installation name on the helideck.
- 1.2 In addition, floodlights may be used for the purpose of providing a source of illumination for on-deck operations, such as refuelling and passenger handling. Any floodlighting provided for on-deck operations should be turned off for the approach, landing and take-off.

## 2 General Considerations for Helideck Floodlighting

- 2.1 The whole of the landing area should be adequately illuminated if intended for night use. Experience has shown that floodlighting systems, even when properly aligned, can adversely affect the visual cueing environment by reducing the conspicuity of helideck perimeter lights during the approach, and by causing glare and loss of pilots' night vision during the hover and landing. Furthermore, floodlighting systems often fail to provide adequate illumination of the centre of the landing area leading to the so-called 'black-hole effect'. It is essential, therefore, that any floodlighting arrangements take full account of these problems. Further good practice guidance on suitable arrangements is provided (below) in paragraph 3 'Improved Floodlighting System', extracted from a further interim guidance letter issued by the CAA on 9 March 2006 and updated for this Appendix.
- 2.2 Although the modified floodlighting schemes described will provide useful illumination of the landing area without significantly affecting the conspicuity of the perimeter lighting and will minimise glare, trials have demonstrated that neither they nor any other floodlighting system is capable of providing the quality of visual cueing available by illuminating the TD/PM and 'H' (see Chapter 4, paragraph 3). These modified floodlighting solutions should therefore be regarded as **temporary arrangements** only. It is essential that any such floodlighting systems are considered in collaboration with the helicopter operator who may wish to fly a non-revenue approach to a helideck at night before confirming the acceptability of the scheme.

- 2.3 The floodlighting should be arranged so as not to dazzle the pilot and, if elevated and located off the landing area clear of the LOS, the system should not present an obstacle to helicopters landing and taking off from the helideck. All floodlights should be capable of being switched on and off at the pilot's request. Setting up of lights should be undertaken with care to ensure that the issues of adequate illumination and glare are properly addressed and regularly checked. For some decks it may be beneficial to improve depth perception by floodlighting the main structure or 'legs' of the platform.

**NOTE:** It is important to confine the helideck lighting to the landing area, since any light overspill may cause reflections from the sea. The floodlighting controls should be accessible to, and controlled by, the HLO or Radio Operator.

### 3 Improved Floodlighting System (a modified extract from the CAA's letter to industry dated 9 March 2006)

- 3.1 For helidecks located on platforms with a sufficiently high level of illumination from cultural lighting, the need for an improved floodlighting system may be reviewed with the helicopter operator(s), i.e. in such circumstances it may be sufficient just to delete or disable the existing deck level floodlighting. This concession assumes that the level of illumination from cultural lighting is also sufficiently high to facilitate deck operations such as movement of passengers and refuelling (where applicable). It is a condition that, prior to the removal of floodlights, extended trials of the 'no-floodlight' configuration are conducted and their subsequent removal will be subject to satisfactory reports from air crews to indicate the acceptability of operating to the helideck with the re-configured lighting.

- 3.2 In the absence of sufficient cultural lighting, the CAA recommends that installation owners consider a deck level floodlighting system consisting of four deck-level xenon floodlights (or alternative lights having the same photometric specification) equally spaced around the perimeter of the helideck. In considering this solution, installation owners should ensure that the deck-level xenon units do not present a source of glare or loss of pilots' night vision on the helideck, and do not affect the ability of the pilots to determine the location of the helideck on the installation. It is therefore essential that all lights are maintained in correct alignment. It is also desirable to position the lights such that no light is pointing directly away from the prevailing wind. Floodlights located on the upwind (for the prevailing wind direction) side of the deck should ideally be mounted so that the centreline of the floodlight beam is at an angle of 45° to the reciprocal of the prevailing wind direction. This will minimise any glare or disruption to the pattern formed by the green perimeter lights for the majority of approaches. An example of an acceptable floodlighting arrangement is shown at Figure 1.

**NOTE:** For some larger helidecks it may be necessary to consider fitting more than four deck-level xenon floodlights (or alternative lights having the same photometric specification), but this should be carefully considered in conjunction with the helicopter operator giving due regard to the issues of glare and loss of definition of the helideck perimeter before further deck-level units are procured. The CAA does not recommend more than six units even on the largest helidecks. The height of any floodlighting when installed around the helideck should not exceed 25 cm above deck level or (for a helideck where the D-value is 16.00 m or less) be more than 5 cm above deck level.

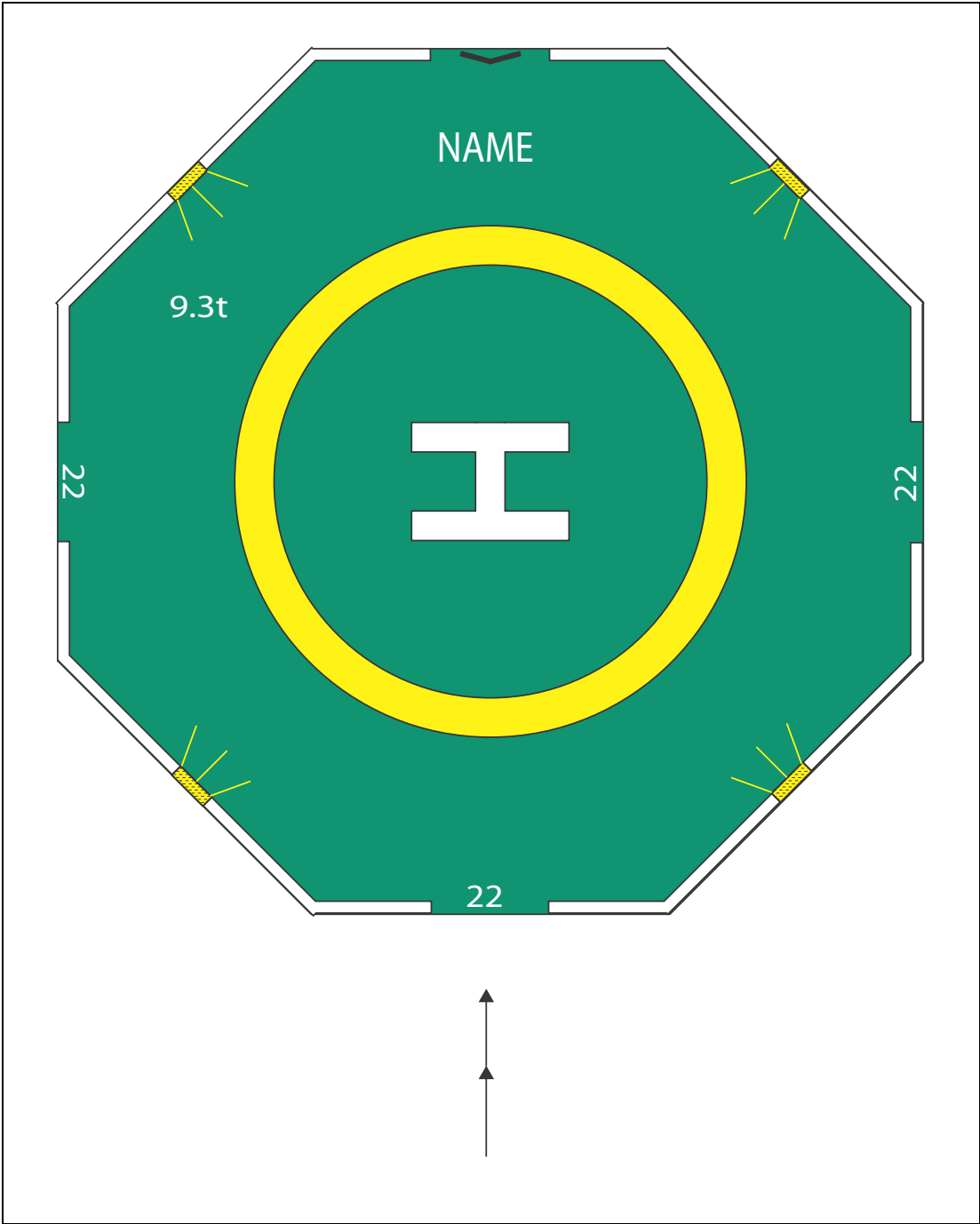

**Figure 1** Typical Floodlighting Arrangement

INTENTIONALLY LEFT BLANK